

POOL & Svømmehal

SORTIMENTSKATALOG

Sikkerhed. Teknik. Design.

Få projekter er så omfattende som poolhuse og svømmehaller. Sikkerhed og teknisk kompetence er afgørende, og for dig som arkitekt er poolhus- og svømmehalsprojekter en enestående mulighed for at du kan udtrykke dig i farver og former.

I forbindelse med poolhus- og svømmehalsprojekter samarbejder vi med interbau-blink og Mapei. To virksomheder med kvalitetsprodukter og stor teknisk kompetence, og det garanterer et projekt af højeste kvalitet.

Kombineret med vores eget sortiment af fliser og klinker leverer vi en totalløsning for hele projektet. Fra reception og offentlige områder til brusebade, omklædningsrum og bassiner.

Kvalitet og viden – som vi har leveret siden 1886.



Forsgrenska badet, Medborgarhuset, Stockholm

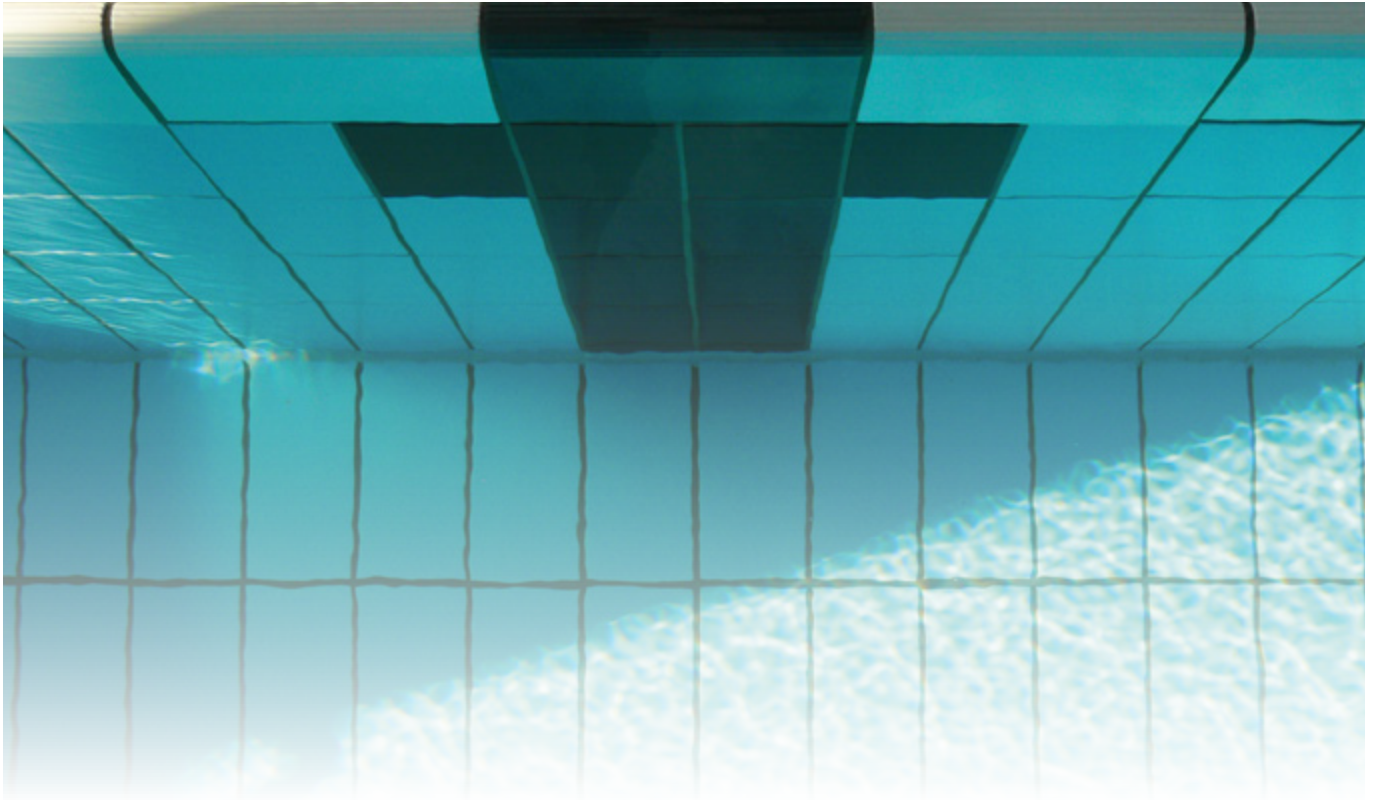

SWIMMING POOL CERAMICS

100 % MADE IN GERMANY

interbau-blink succeeded in proving itself as specialist for swimming pool solutions. Our swimming pool ceramic programme unfailingly offers an appealing and technically secure solution for public sports facilities, public pools, hotel pools, therapy or private pools.

Ceramic tiles and special pieces made by **interbau-blink** distinguish themselves by their long durability, colour fastness and non-fade properties. They offer optimal hygiene, are particularly low-maintenance and resistant against frost, heat and aggressive substances. All special pieces are extruded and therefore exceedingly true to contour and produced under a high quality standard, based on decades of experience, qualified employees and modern production technology.

MAXIMAL CREATIVITY IN SHAPE & COLOUR

Technical proficiency and industrial production technology at the highest level not only guarantee top quality but also allow a great measure of flexibility for individual planning requirements.

Around 100 basic contours in different lengths offer our special solutions the maximal creative range in line and contour as well as a perfect detail development. The VarioCOLOR colour programme with 52 mono-colours offers unlimited combination possibilities. Clear and vibrant shades from every colour range support individual, creative leeway for indoor and outdoor areas. Particular highlights can be made with the 11 intense and basic colours of the VarioCOLOR programme.

Of course custom-made designs and productions in individual colours are part of our wide-ranged product portfolio.

CONTENT

COLOUR RANGE

- S. 6 VarioCOLOR semi gloss [colour groups]
- S. 8 VarioCOLOR glossy [basic & intensive colours]
- S. 9 VarioCOLOR slip resistant [glazed & unglazed]

BASIC TILES & SPLIT TILES

- S. 10 VarioCOLOR semi gloss
- S. 12 VarioCOLOR glossy
- S. 14 VarioCOLOR slip resistant

POOL EDGE SYSTEMS

- S. 18 **System Wiesbaden** | high water level | large & small channel
- S. 20 **System Wiesbaden with recess** | high water level | large & small channel
- S. 22 **System Wiesbaden** | low water level | large channel
- S. 22 **Therapy Pool System**
- S. 24 **System Finland 1** | high water level
- S. 25 **System Finland 2** | high water level
- S. 26 **System Finland 3** | high water level
- S. 27 **System Finland** | range of shape tiles
- S. 28 **System Berlin** | high water level
- S. 28 **System Zürich** | high water level
- S. 29 **System St. Moritz** | water level over pool surrounding
- S. 30 **System Skimmer** | for flat pool edges

SHAPE TILES & SPECIAL PARTS

- S. 32 Radial tiles & coved tile systems
- S. 36 Grooved tiles & special tiles
- S. 38 Special tiles, ladder step tiles & lettering tiles
- S. 40 Special shapes for channels and drains
- S. 42 Accessories [gratings for channels & drain valves]

TECHNICAL INFORMATION & ITEM INDEX

- S. 44 Competition pools according to FINA standards
- S. 46 Instructions for cleaning and maintenance
- S. 46 Valuation groups in wet barefoot areas
- S. 47 Norms and test results
- S. 48 Item index & colour range



VarioCOLOR

COLOUR GROUPS | GLAZED | SEMI GLOSS

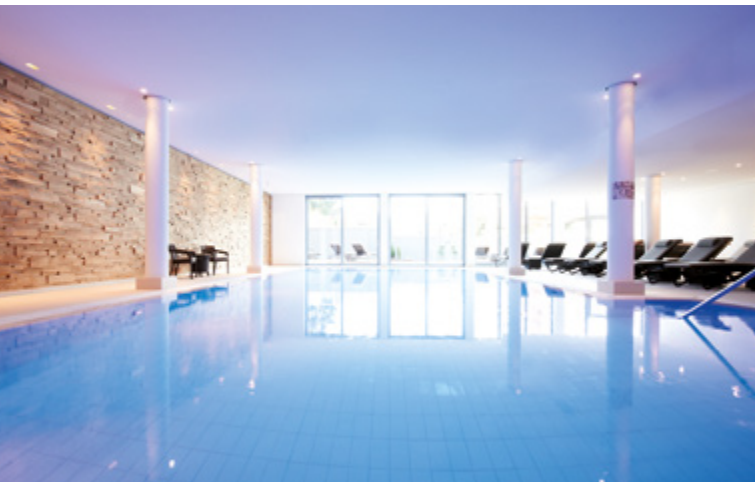

The VarioCOLOR colour system

The colours of the VarioCOLOR range are influenced and developed considering latest colour technologies. The balanced definition of colours provides clear and powerful colours in any supplied shade. The semi gloss surface of the main colours features elegant presence and is applicable for versatile use. Six intensive colours provide bright and powerful colour effects. High quality colour pigments and optimal composition retain steady colours.

colour group	colour no.	colour description
YELLOW	211	Melonengelb
	251	Maisgelb
	281	Zinkgelb
ORANGE	411	Gelbbraun
	451	Sandbraun
	481	Dunkelorange
GREEN	611	Hellgrün
	641	Seegrün
	681	Maigrün

TURQUOISE

	621	Aquamarin
	661	Türkis
	671	Minttürkis

AZURE

	721	Hellblau
	741	Himmelblau
	761	Stahlblau
	781	Azurblau

BLUE

	511	Eisblau
	521	Pastellblau
	531	Kornblumenblau
	541	Royalblau
	561	Dunkelblau
	581	Ultramarinblau

BEIGE



- 111 Hellelfenbein
- 121 Beige
- 141 Braunbeige
- 151 Orangebraun
- 171 Signalbraun
- 191 Terrabraun

WHITE/BLACK



- 901 Weiß
- 911 Lichtgrau
- 921 Hellgrau
- 931 Grau
- 951 Dunkelgrau
- 971 Anthrazitgrau
- 991 Schwarz

BROWN



- 811 Sesam
- 821 Lachs
- 841 Sienaerde
- 861 Sattelbraun
- 871 Nussbraun
- 881 Schokobraun



SEMI GLOSS

VarioCOLOR

BASIC & INTENSIVE COLOURS | GLAZED | GLOSSY

BASIC COLOURS



- 900 Weiß
- 710 Lichtblau
- 790 Azur dunkel
- 590 Kobaltblau
- 990 Schwarz

INTENSIVE COLOURS



- 270 Schwefelgelb
- 470 Dahliengelb
- 490 Orange
- 370 Feuerrot
- 630 Gelbgrün
- 650 Limette

BASIC & INTENSIVE



VarioCOLOR

SLIP RESISTANT | GLAZED

COLOURS ANTISKID | GLAZED



906 Weiß	antiskid "B"	908 Weiß	antiskid "C"
716 Lichtblau	antiskid "B"	718 Lichtblau	antiskid "C"
786 Azurblau	antiskid "B"	788 Azurblau	antiskid "C"
796 Azur dunkel	antiskid "B"	798 Azur dunkel	antiskid "C"
996 Schwarz	antiskid "B"	998 Schwarz	antiskid "C"

VarioCOLOR

SLIP RESISTANT | UNGLAZED

COLOURS ANTISKID | UNGLAZED | R 10/B



892 Naturbeige	R 10/B
890 Naturweiß	R 10/B
894 Neutralgrau	R 10/B
896 Anthrazit	R 10/B

COLOURS ANTISKID | UNGLAZED | PROFILED

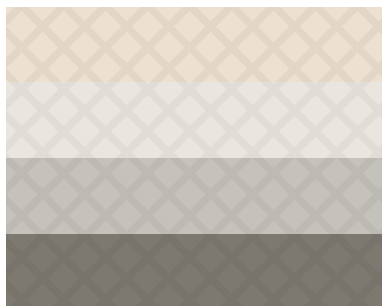

893 Naturbeige	R 11/C	profiled
891 Naturweiß	R 11/C	profiled
895 Neutralgrau	R 11/C	profiled
897 Anthrazit	R 11/C	profiled

COLOURS ANTISKID | UNGLAZED | ENGOBED | ANTISKID A-C

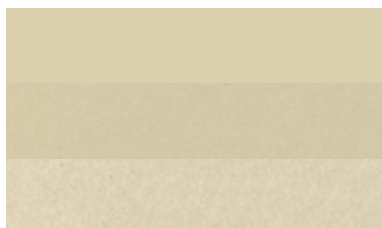

























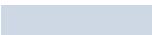











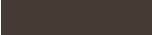

690 Graugelb	R 10/A
691 Graugelb	R 11/BC
693 Graucreme	R 11/B

SLIP
RESISTANT

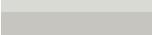
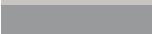
BASIC TILES & SPLIT TILES | SEMI GLOSS

FOR WALL AREAS AND POOLS

YELLOW		211 Melonengelb
		251 Maisgelb
		281 Zinkgelb
ORANGE		411 Gelbbraun
		451 Sandbraun
		481 Dunkelorange
GREEN		611 Hellgrün
		641 Seegrün
		681 Maigrün
TURQUOISE		621 Aquamarin
		661 Türkis
		671 Minttürkis
AZURE		721 Hellblau
		741 Himmelblau
		761 Stahlblau
		781 Azurblau
BLUE		511 Eisblau
		521 Pastellblau
		531 Kornblumenblau
		541 Royalblau
		561 Dunkelblau
		581 Ultramarinblau
BEIGE		111 Hellelfenbein
		121 Beige
		141 Braunbeige
		151 Orangebraun
		171 Signalbraun
BROWN		191 Terrabraun
		811 Sesam
		821 Lachs
		841 Sienaerde
		861 Sattelbraun
WHITE/BLACK		871 Nussbraun
		881 Schokobraun
		901 Weiß
		911 Lichtgrau
		921 Hellgrau
WHITE/BLACK		931 Grau
		951 Dunkelgrau
		971 Anthrazitgrau
		991 Schwarz

Basic tiles VarioCOLOR | semi gloss

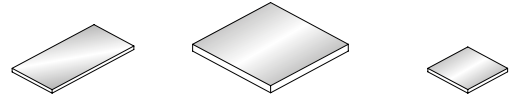

	Basic tile standard	Basic tile large*	Basic tile small*
Item no.	1200	2424	1212
Coordinating size in mm	250 x 125 x 7,5	250 x 250 x 7,5	125 x 125 x 7,5
Work size in mm	244 x 119 x 7,5	244 x 244 x 7,5	119 x 119 x 7,5

Unit	m ²	m ²	m ²
Pcs/m ²	32	16	64
Approx. kg/pc	0,48	1,00	0,24
Pcs per box	40	20	80
m ² per box	1,25	1,25	1,25
Pcs per pallet	2880	1440	5760
Approx. kg/pallet	1410	1470	1410
m ² per pallet	90	90	90
Boxes per pallet	72	72	72

Colour groups colours	Article no. PG	Article no. PG	Article no. PG
YELLOW	31 1200 - colour no. 703	32 2424 - colour no. 713	32 1212 - colour no. 723
ORANGE	31 1200 - colour no. 703	32 2424 - colour no. 713	32 1212 - colour no. 723
GREEN	31 1200 - colour no. 703	32 2424 - colour no. 713	32 1212 - colour no. 723
TURQUOISE	31 1200 - colour no. 703	32 2424 - colour no. 713	32 1212 - colour no. 723
AZURE	31 1200 - colour no. 703	32 2424 - colour no. 713	32 1212 - colour no. 723
BLUE	31 1200 - colour no. 703	32 2424 - colour no. 713	32 1212 - colour no. 723
BEIGE**	31 1200 - colour no. 703	32 2424 - colour no. 713	32 1212 - colour no. 723
BROWN	31 1200 - colour no. 703	32 2424 - colour no. 713	32 1212 - colour no. 723
WHITE/BLACK**	31 1200 - colour no. 703	32 2424 - colour no. 713	32 1212 - colour no. 723

Hellelfenbein	31 1200 111 702	32 2424 111 712	32 1212 111 722
Weiß	31 1200 901 701	32 2424 901 711	32 1212 901 721
Lichtgrau	31 1200 911 702	32 2424 911 712	32 2424 911 722

PG = price group | * Order related production, please request minimum order quantities (MOQ).

** Different price groups within the colour group are listed separately.

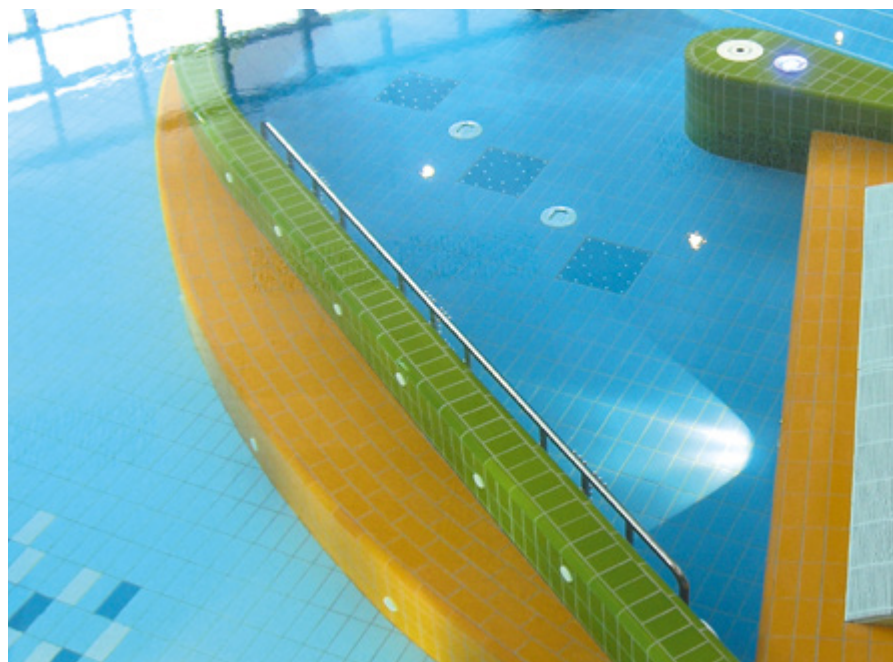

Split tiles VarioCOLOR | semi gloss

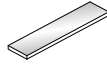
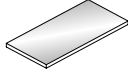

	Split tile*	Split tile*
Item no.	1100	2120
Coordinating size in mm	250 x 125 x 10	250 x 62 x 10
Work size in mm	240 x 115 x 10	240 x 52 x 10

Unit	m²	m²
Pcs/m ²	33	67
Approx. kg/pc	0,58	0,26
Pcs per box	23	44
m ² per box	0,70	0,66
Pcs per pallet	2415	4620
Approx. kg/pallet	1420	1220
m ² per pallet	73,50	68,96
Boxes per pallet	105	105

Colour groups colours	Article no. PG	Article no. PG
YELLOW	41 1100 - colour no. 610	43 2120 - colour no. 623
ORANGE	41 1100 - colour no. 610	43 2120 - colour no. 623
GREEN	41 1100 - colour no. 610	43 2120 - colour no. 623
TURQUOISE	41 1100 - colour no. 610	43 2120 - colour no. 623
AZURE	41 1100 - colour no. 610	43 2120 - colour no. 623
BLUE	41 1100 - colour no. 610	43 2120 - colour no. 623
BEIGE	41 1100 - colour no. 610	43 2120 - colour no. 623
BROWN	41 1100 - colour no. 610	43 2120 - colour no. 623
WHITE/BLACK**	41 1100 - colour no. 580	43 2120 - colour no. 623

Weiß	41 1100 901 562	43 2120 901 582
Dunkelgrau	41 1100 951 590	corresp. PG WHITE/BLACK
Anthrazitgrau	41 1100 971 590	corresp. PG WHITE/BLACK
Schwarz	41 1100 991 623	corresp. PG WHITE/BLACK

The article basic tile 1200 and split tile 1100 are available with **glazed edges [PG 770]**.

Please add the following abbreviations to the article number:

Short glazed edge: **KK** | Long glazed edge: **LK**

Corner glazed left: **EKL** | Corner glazed right: **EKR**



The article basic tile 1200 and split tile 1100 are available with **glazed rounded edges [PG 506]**.

Please add the following abbreviations to the article number:





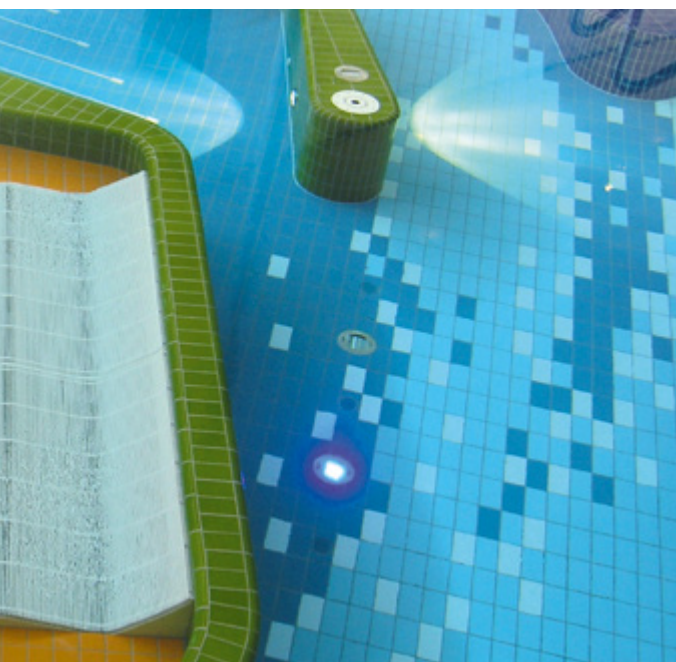
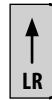

Short rounded edge: **KR** | Long rounded edge: **LR**





Corner rounded left: **ERL** | Corner rounded right: **ERR**



BASIC TILES & SPLIT TILES | GLOSSY

FOR WALL AREAS AND POOLS

INTENSIVE COLOURS		270 Schwefelgelb
		470 Dahliengelb
		490 Orange
		370 Feuerrot
		630 Gelbgrün
		650 Limette

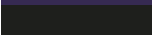
BASIC COLOURS		900 Weiß
		710 Lichtblau
		790 Azur dunkel
		590 Kobaltblau
		990 Schwarz

Basic tiles VarioCOLOR | intensive & basic colours | glossy

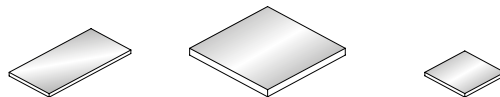

	Basic tile standard	Basic tile large*	Basic tile small*
Item no.	1200	2424	1212
Coordinating size in mm	250 x 125 x 7,5	250 x 250 x 7,5	125 x 125 x 7,5
Work size in mm	244 x 119 x 7,5	244 x 244 x 7,5	119 x 119 x 7,5

	m ²	m ²	m ²
Unit			
Pcs/m ²	32	16	64
Approx. kg/pc	0,48	1,00	0,24
Pcs per box	40	20	80
m ² per box	1,25	1,25	1,25
Pcs per pallet	2880	1440	5760
Approx. kg/pallet	1410	1470	1410
m ² per pallet	90	90	90
Boxes per pallet	72	72	72

Colour groups colours	Article no. PG	Article no. PG	Article no. PG
INTENSIVE COLOURS	31 1200 - colour no. 644	32 2424 - colour no. 723	32 1212 - colour no. 723

BASIC COLOURS	Article no. PG	Article no. PG	Article no. PG
Weiß	31 1200 900 701	32 2424 900 711	32 1212 900 723
Lichtblau	31 1200 710 702	32 2424 710 712	32 1212 710 723
Azur dunkel	31 1200 790 703	32 2424 790 713	32 1212 790 723
Kobaltblau	31 1200 590 703	32 2424 590 713	32 1212 590 723
Schwarz	31 1200 990 703	32 2424 990 713	32 1212 990 723

PG = price group | * Order related production, please request minimum order quantities (MOQ).

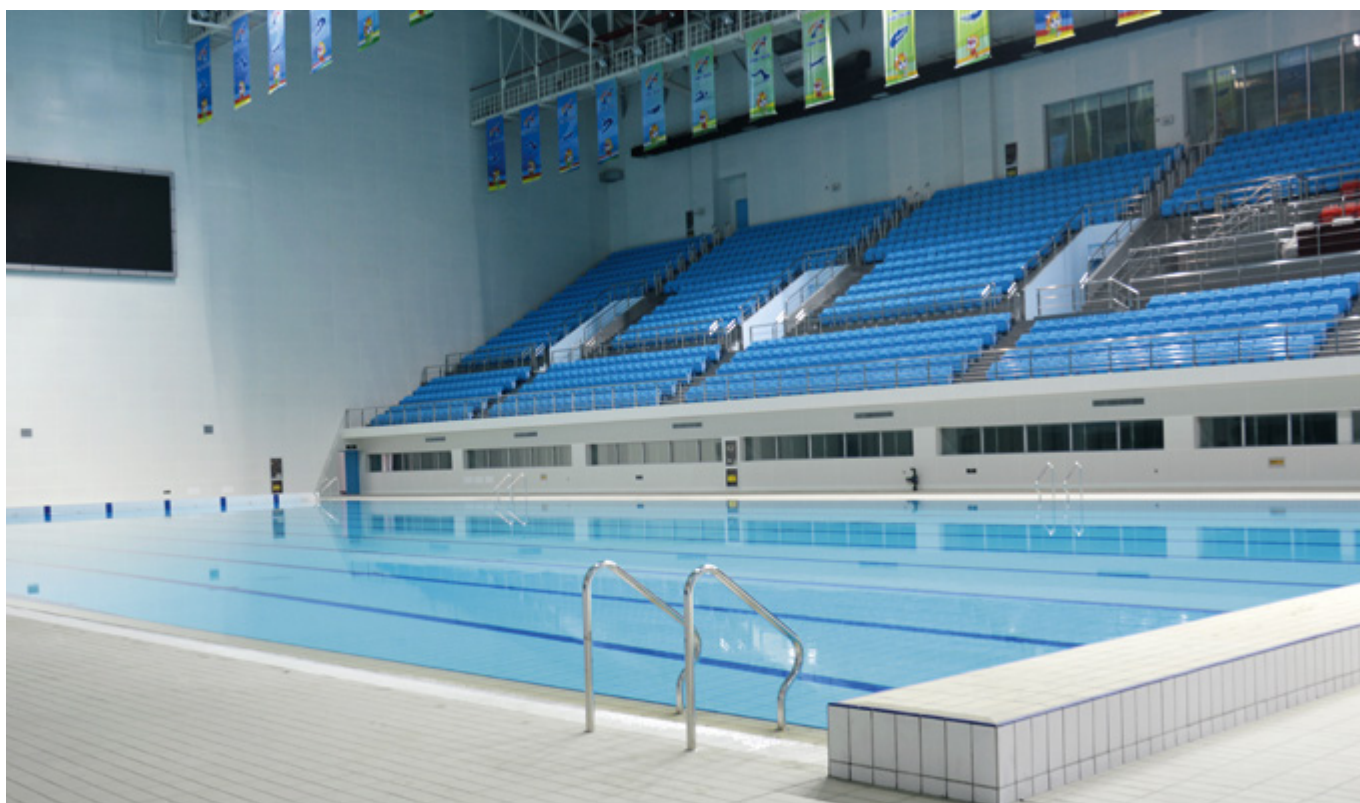

Split tiles VarioCOLOR | intensive & basic colours | glossy

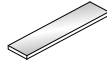
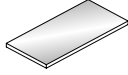

	Split tile*	Split tile*
Item no.	1100	2120
Coordinating size in mm	250 x 125 x 10	250 x 62 x 10
Work size in mm	240 x 115 x 10	240 x 52 x 10

Unit	m²	m²
Pcs/m ²	33	67
Approx. kg/pc	0,58	0,26
Pcs per box	23	44
m ² per box	0,70	0,66
Pcs per pallet	2415	4620
Approx. kg/pallet	1420	1220
m ² per pallet	73,50	68,96
Boxes per pallet	105	105

Colour groups colours	Article no. PG	Article no. PG
INTENSIVE COLOURS	41 1100 - colour no. 644	43 2120 - colour no. 663

BASIC COLOURS	Article no. PG	Article no. PG
Weiß	41 1100 900 562	43 2120 900 582
Lichtblau	41 1100 710 580	43 2120 710 605
Azur dunkel	41 1100 790 610	43 2120 790 623
Kobaltblau	41 1100 590 610	43 2120 590 623
Schwarz	41 1100 990 610	43 2120 990 623

The article basic tile 1200 and split tile 1100 are available with glazed edges [PG 770].

Please add the following abbreviations to the article number:

Short glazed edge: **KK** | Long glazed edge: **LK**

Corner glazed left: **EKL** | Corner glazed right: **EKR**



The article basic tile 1200 and split tile 1100 are available with glazed rounded edges [PG 506].

Please add the following abbreviations to the article number:



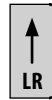

Short rounded edge: **KR** | Long rounded edge: **LR**





Corner rounded left: **ERL** | Corner rounded right: **ERR**





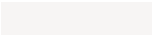





BASIC TILES & SPLIT TILES | SLIP RESISTANT



FOR FLOORS

ANTISKID B GLAZED		906 Weiß	B
		716 Lichtblau	B
		786 Azurblau	B
		796 Azur dunkel	B
		996 Schwarz	B

ANTISKID C GLAZED		908 Weiß	C
		718 Lichtblau	C
		788 Azurblau	C
		798 Azur dunkel	C
		998 Schwarz	C

ANTISKID UNGLAZED		892 Naturbeige	R 10/B
		890 Naturweiß	R 10/B
		894 Neutralgrau	R 10/B
		896 Anthrazit	R 10/B

ANTISKID UNGL. PROFILED		893 Naturbeige	R 11/C
		891 Naturweiß	R 11/C
		895 Neutralgrau	R 11/C
		897 Anthrazit	R 11/C

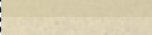
ANTISKID UNGL. ENGOBED		690 Graugelb	R 10/A
		691 Graugelb	R 11/BC
		693 Graucreme	R 11/B

Basic tiles VarioCOLOR | slip resistant

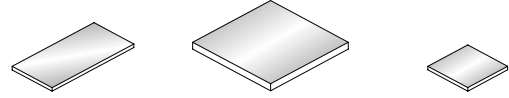

	Basic tile standard	Basic tile large*	Basic tile small*
Item no.	1200	2424	1212
Coordinating size in mm	250 x 125 x 7,5	250 x 250 x 7,5	125 x 125 x 7,5
Work size in mm	244 x 119 x 7,5	244 x 244 x 7,5	119 x 119 x 7,5

Unit	m ²	m ²	m ²
Pcs/m ²	32	16	64
Approx. kg/pc	0,48	1,00	0,24
Pcs per box	40	20	80
m ² per box	1,25	1,25	1,25
Pcs per pallet	2880	1440	5760
Approx. kg/pallet	1410	1470	1410
m ² per pallet	90	90	90
Boxes per pallet	72	72	72

Colours antiskid, glazed	Article no. PG	Article no. PG	Article no. PG
Weiß B C	31 1200 - colour no. 731	32 2424 - colour no. 741	32 1212 - colour no. 751
Lichtblau B C	31 1200 - colour no. 731	32 2424 - colour no. 741	32 1212 - colour no. 751
Azurblau B C	31 1200 - colour no. 732	32 2424 - colour no. 742	32 1212 - colour no. 752
Azur dunkel B C	31 1200 - colour no. 732	32 2424 - colour no. 742	32 1212 - colour no. 752
Schwarz B C	31 1200 - colour no. 732	32 2424 - colour no. 742	32 1212 - colour no. 752

Colours antiskid, ungl.	Article no. PG	Article no. PG	Article no. PG
UNGLAZED	31 1200 - colour no. 761	32 2424 - colour no. 762	32 1212 - colour no. 763
UNGLAZED PROFILED	31 1200 - colour no. 761	32 2424 - colour no. 762	32 1212 - colour no. 763

PG = price group | * Order related production, please request minimum order quantities (MOQ).

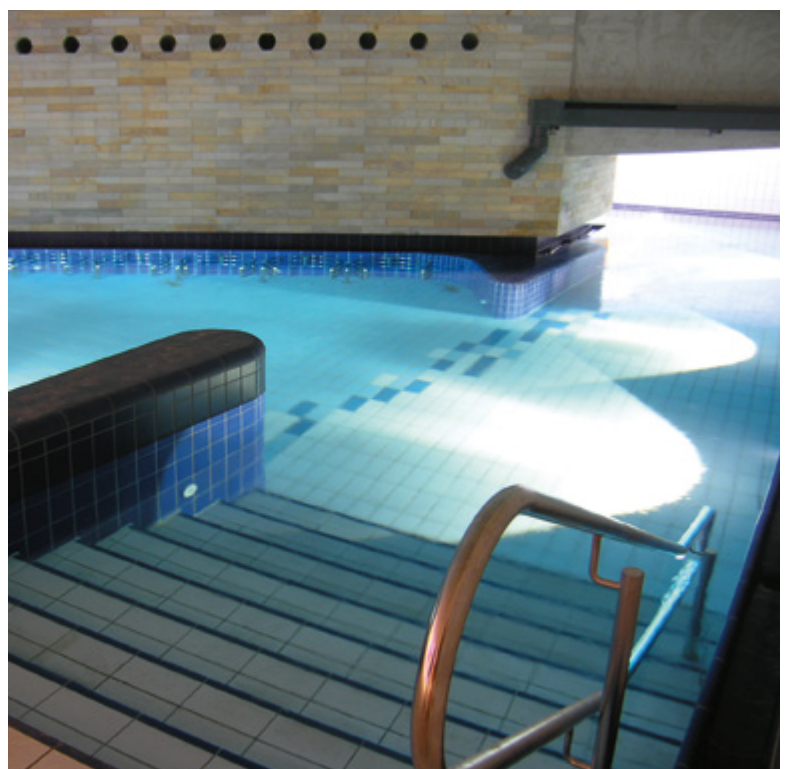

Split tiles VarioCOLOR | slip resistant

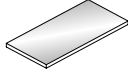

	Split tile*
Item no.	1100
Coordinating size in mm	250 x 125 x 10
Work size in mm	240 x 115 x 10

Unit	m ²
Pcs/m ²	33
Approx. kg/pc	0,58
Pcs per box	23
m ² per box	0,70
Pcs per pallet	2415
Approx. kg/pallet	1420
m ² per pallet	73,50
Boxes per pallet	105

Colours antiskid, glazed	Article no. PG
Weiß	41 1100 - colour no. 576
Lichtblau	41 1100 - colour no. 590
Azurblau	41 1100 - colour no. 611
Azur dunkel	41 1100 - colour no. 611
Schwarz	41 1100 - colour no. 611

Colours antiskid, ungl.	Article no. PG
UNGLAZED Graugelb	41 1100 - colour no. 562
UNGLAZED Graucreme	11 1100 - 693 562

The article basic tile 1200 and split tile 1100 are available with **glazed edges [PG 770]**.

Please add the following abbreviations to the article number:

Short glazed edge: **KK** | Long glazed edge: **LK**

Corner glazed left: **EKL** | Corner glazed right: **EKR**

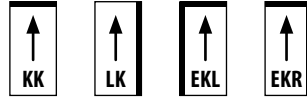

The article basic tile 1200 and split tile 1100 are available with **glazed rounded edges [PG 506]**.

Please add the following abbreviations to the article number:

Short rounded edge: **KR** | Long rounded edge: **LR**

Corner rounded left: **ERL** | Corner rounded right: **ERR**

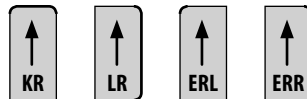

POOL EDGE SYSTEMS

OVERFLOW CHANNELS AND VARIATIONS OF EDGE SYSTEMS





SPECIAL CERAMICS FOR SWIMMING POOL CONSTRUCTION IN HIGHEST QUALITY

The detailed drawings shown on this page should generally inform about our products and their application. In respect of the differences of the possible applications and the general surrounding conditions on the construction sight, these indications can only be considered as general information that will not guarantee any characteristics of our products in particular.

For dimensional sketches please contact us: info@interbau-blink.de

POOL EDGE SYSTEMS

Decisive criteria for the construction are taken from the following leaflets and guidelines issued by the below mentioned German institutes and associations:

- Bundesfachverband öffentliche Bäder e. V.
- Deutsche Gesellschaft für das Badewesen [z. B. KOK Richtlinien für den Schwimmbadbau]
- Zentralverband des Deutschen Baugewerbes [ZDB-Merkblätter]
- Contracting rules for award of public works
- HV der gewerblichen Berufsgenossenschaften [BG-Merkblätter Trittsicherheit]
- Bundesverband der Unfallkassen [GUV-Merkblätter Trittsicherheit]
- DIN | EN | ISO standards



SYSTEM WIESBADEN

HIGH WATER LEVEL

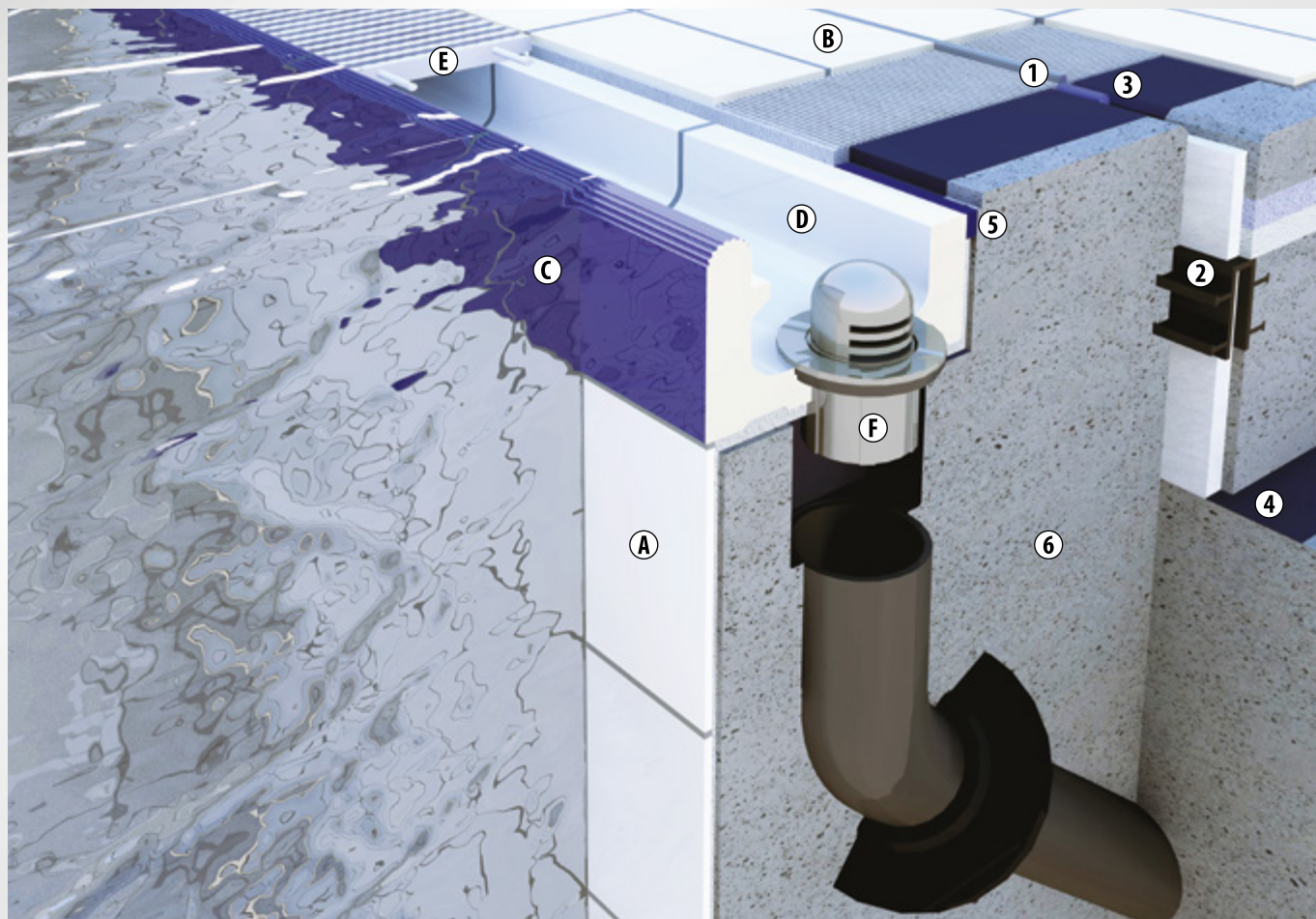

Item index | System Wiesbaden, small channel

Item description	Item no.
A Basic tile standard glazed	1200
B Basic tile standard antiskid glazed	1200 RH
C Overflow channel, small	5170
D Overflow channel with drainage	5171
E Grating, rigid	1218
F Drain valve, silent, 2 1/2"	5202

1 Expansion joint

2 Joint band

3 Expansion joint with polyethylen foam round lace

4 Slide bearing

5 Capillary break joint filling

6 Water resistant concrete

Features:

With shaped ceramic in one piece you achieve a safe possibility for a handgrip for swimmers and a drain with a support for the grating.

The water level is approximately 3 cm above the pool surrounding, giving the following advantages:

- Swimmers can be guarded easily.
- Good view to the outside.
- No disturbing smells due to chlorine concentration.

SYSTEM
WIESBADEN

System Wiesbaden | large channel | grating width 250 mm | high water level

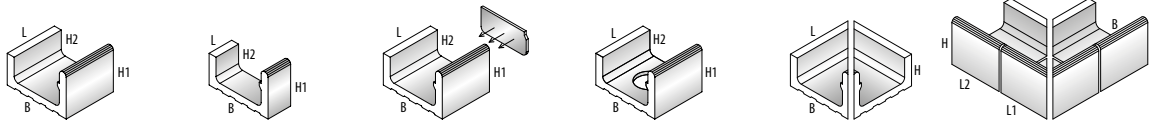

	Overflow channel large	½ Overflow channel large	Stop end set of two pcs left: 5304 right: 5306	Overflow channel with drainage ø = 85 mm	Internal corner set of two pcs	External corner set of four pcs
Item no.	5300	5305		5301	5302	5307
Dimensions	L x B x H1 H2	L x B x H1 H2	L x B x H1 H2	L x B x H1 H2	L x B x H	L1 x L2 x B x H
Work size in mm	244 x 300 x 200 140	119 x 300 x 200 140	244 x 300 x 200 140	244 x 300 x 200 140	(2 x) 293 x 300 x 140	(two times each) 238 x 244 x 300 x 200

Unit	pc	pc	set	pc	set	set
Pcs/l.m. incl. joint	4	8	-	-	-	-
Approx. kg/pc	12,0	6,0	12,7	11,8	9,5	31,5
Pcs per box	1	2	1 set	1	1 set	1 set

Colour groups colours	Article no. PG	Article no. PG	Article no. PG	Article no. PG	Article no. PG	Article no. PG
VarioCOLOR programme*	66 5300 - colour no. 653	66 5305 - colour no. 631	66 5304/06 - colour no. 658	66 5301 - colour no. 658	66 5302 - colour no. 665	66 5307 - colour no. 667
Weiß semi gloss	66 5300 901 650	66 5305 901 622	66 5304/06 901 657	66 5301 901 657	66 5302 901 664	66 5307 901 666
Weiß glossy	66 5300 900 650	66 5305 900 622	66 5304/06 900 657	66 5301 900 657	66 5302 900 664	66 5307 900 666
Lichtblau glossy	66 5300 710 650	66 5305 710 622	66 5304/06 710 657	66 5301 710 657	66 5302 710 664	66 5307 710 666

System Wiesbaden | small channel | grating width 185 mm | high water level

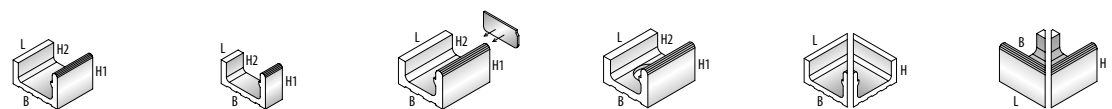

	Overflow channel small	½ Overflow channel small	Stop end set of two pcs left: 5174 right: 5176	Overflow channel with drainage ø = 85 mm	Internal corner set of two pcs	External corner set of two pcs
Item no.	5170	5175		5171	5172	5177
Dimensions	L x B x H1 H2	L x B x H1 H2	L x B x H1 H2	L x B x H1 H2	L x B x H	L x B x H
Work size in mm	244 x 225 x 160 115	119 x 225 x 160 115	244 x 225 x 160 115	244 x 225 x 160 115	(2 x) 218 x 225 x 115	(2 x) 238 x 225 x 160

Unit	pc	pc	set	pc	set	set
Pcs/l.m. incl. joint	4	8	-	-	-	-
Approx. kg/pc	9,0	4,5	9,5	8,4	7,0	7,0
Pcs per box	1	2	1 set	1	1 set	1 set

Colour groups colours	Article no. PG	Article no. PG	Article no. PG	Article no. PG	Article no. PG	Article no. PG
VarioCOLOR programme*	66 5170 - colour no. 634	66 5175 - colour no. 602	66 5174/76 - colour no. 648	66 5171 - colour no. 648	66 5172 - colour no. 660	66 5177 - colour no. 660
Weiß semi gloss	66 5170 901 628	66 5175 901 597	66 5174/76 901 645	66 5171 901 645	66 5172 901 659	66 5177 901 659
Weiß glossy	66 5170 900 628	66 5175 900 597	66 5174/76 900 645	66 5171 900 645	66 5172 900 659	66 5177 900 659
Lichtblau glossy	66 5170 710 628	66 5175 710 597	66 5174/76 710 645	66 5171 710 645	66 5172 710 659	66 5177 710 659



* Different price groups within the colour group are listed separately.

SYSTEM WIESBADEN

HIGH WATER LEVEL | OVERFLOW CHANNEL WITH RECESS

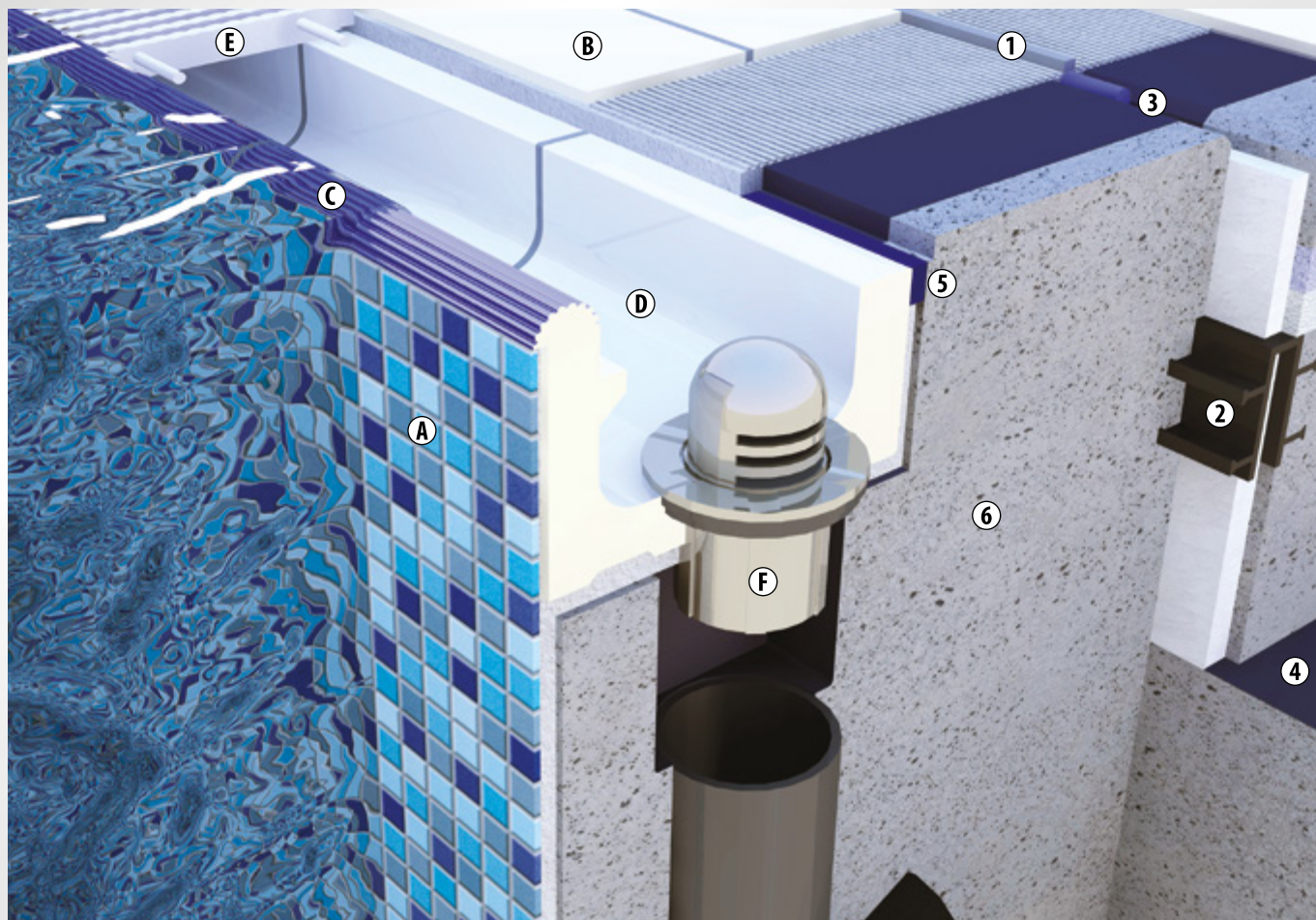

Item index | Overflow channel, small

Item description	Item no.
A Tile of your choice or mosaic, glazed	
B Basic tile standard antiskid glazed	1200 RH
C Overflow channel, small	5270
D Overflow channel with drainage	5271
E Grating, rigid	1218
F Drain valve, silent, 2 1/2"	5202
1 Expansion joint	
2 Joint band	
3 Expansion joint with polyethylen foam round lace	
4 Slide bearing	
5 Capillary break joint filling	
6 Water resistant concrete	

Features:

The front part of the Wiesbaden channel can be applied with an individual surface, offering an endless variety of design possibilities. The formed ceramic Wiesbaden channel system with a high water level offers the same advantages compared to the regular Wiesbaden system. The channel enables swimmers to have a safe grip on the pool edge and additionally offers a support for the grating on top. The water level is approximately 3 cm on top of the surrounding area outside of the pool.

- Simple surveillance of the swimmers.
- Good visibility conditions to the exterior of the pool.
- No chlorine smell inside the pool.

SYSTEM
WIESBADEN

System Wiesbaden | large channel | grating width 250 mm | high water level and recess [Tiles or mosaic can be installed on the front side.]

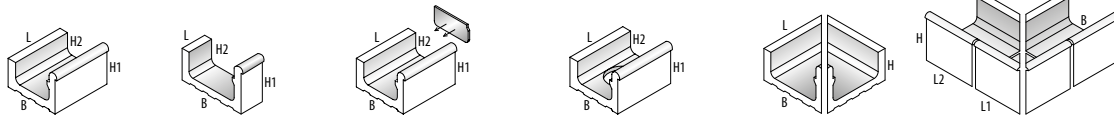

	Overflow channel large smooth edge	½ Overflow channel large smooth edge	Stop end set of two pcs	Overflow channel w. drainage smooth edge $\phi = 85$ mm	Internal corner set of two pcs	External corner set of four pcs
Item no.	5500	5505	left: 5504 right: 5506	5501	5502	5507
Dimensions	L x B x H1 H2	L x B x H1 H2	L x B x H1 H2	L x B x H1 H2	L x B x H1 H2	L1 x L2 x B x H
Work size in mm	244 x 300 x 200 140	119 x 300 x 200 140	244 x 300 x 200 140	244 x 300 x 200 140	(2 x) 293 x 300 x 140	(two times each) 238 x 244 x 200

Unit	pc	pc	set	pc	set	set
Pcs/l.m. incl. joint	4	8	-	-	-	-
Approx. kg/pc	12,0	6,0	13,0	11,8	9,5	31,5
Pcs per box	1	2	1 set	1	1 set	1 set

Colour groups colours	Article no. PG	Article no. PG	Article no. PG	Article no. PG	Article no. PG	Article no. PG
VarioCOLOR programme*	66 5500 - colour no. 660	66 5505 - colour no. 650	66 5504/06 - colour no. 662	66 5501 - colour no. 662	66 5502 - colour no. 674	66 5507 - colour no. 667
Weiß semi gloss	66 5500 901 659	66 5505 901 649	66 5504/06 901 661	66 5501 901 661	66 5502 901 673	66 5507 901 666
Weiß glossy	66 5500 900 659	66 5505 900 649	66 5504/06 900 661	66 5501 900 661	66 5502 900 673	66 5507 900 666
Lichtblau glossy	66 5500 710 659	66 5505 710 649	66 5504/06 710 661	66 5501 710 661	66 5502 710 673	66 5507 710 666

System Wiesbaden | small channel | grating width 185 mm | high water level and recess [Tiles or mosaic can be installed on the front side.]

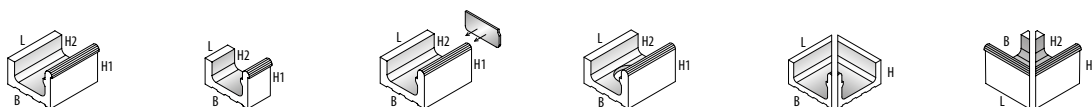

	Overflow channel small	½ Overflow channel small	Stop end set of two pcs	Overflow channel with drainage $\phi = 85$ mm	Internal corner set of two pcs	External corner set of two pcs
Item no.	5270	5275	left: 5274 right: 5276	5271	5272	5277
Dimensions	L x B x H1 H2	L x B x H1 H2	L x B x H1 H2	L x B x H1 H2	L x B x H	L x B x H1 H2
Work size in mm	244 x 225 x 160 115	119 x 225 x 160 115	244 x 225 x 160 115	244 x 225 x 160 115	(2 x) 218 x 225 x 115	(2 x) 238 x 225 x 160 115

Unit	pc	pc	set	pc	set	set
Pcs/l.m. incl. joint	4	8	-	-	-	-
Approx. kg/pc	8,4	4,2	8,9	7,8	6,4	7,0
Pcs per box	1	2	1 set	1	1 set	1 set

Colour groups colours	Article no. PG	Article no. PG	Article no. PG	Article no. PG	Article no. PG	Article no. PG
VarioCOLOR programme*	66 5270 - colour no. 653	66 5275 - colour no. 631	66 5274/76 - colour no. 658	66 5271 - colour no. 658	66 5272 - colour no. 665	66 5277 - colour no. 665
Weiß semi gloss	66 5270 901 650	66 5275 901 622	66 5274/76 901 657	66 5271 901 657	66 5272 901 670	66 5277 901 670
Weiß glossy	66 5270 900 650	66 5275 900 622	66 5274/76 900 657	66 5271 900 657	66 5272 900 670	66 5277 900 670
Lichtblau glossy	66 5270 710 650	66 5275 710 622	66 5274/76 710 657	66 5271 710 657	66 5272 710 670	66 5277 710 670

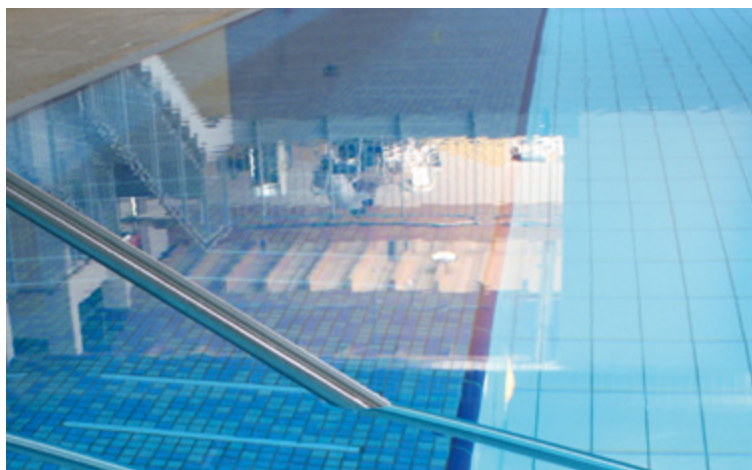

* Different price groups within the colour group are listed separately.

SYSTEM WIESBADEN

LOW WATER LEVEL

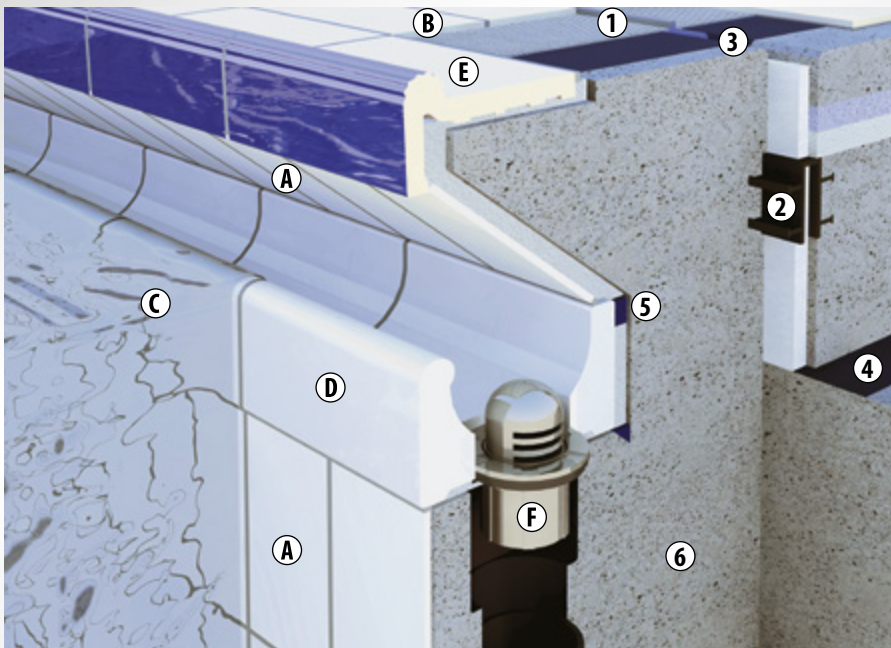

Item index | System Wiesbaden, low water level

Item description	Item no.
A Basic tile standard glazed	1200
B Basic tile standard antiskid glazed	1200 RH
C Overflow channel	5100
D Overflow channel with drainage	5101
E Pool edging tile	5450
F Drain valve, silent, 2 1/2"	5202

1 Expansion joint
2 Joint band
3 Expansion joint with polyethylen foam round lace
4 Slide bearing
5 Capillary break joint filling
6 Water resistant concrete

Features:

Just like the overflow channel with a high water level the shaped ceramics made of one piece enable a safe possibility for a hand grip and as overflow. A grating is not required. With this system the water level is 20 to 25 cm below the pool surrounding.

THERAPY POOL SYSTEM

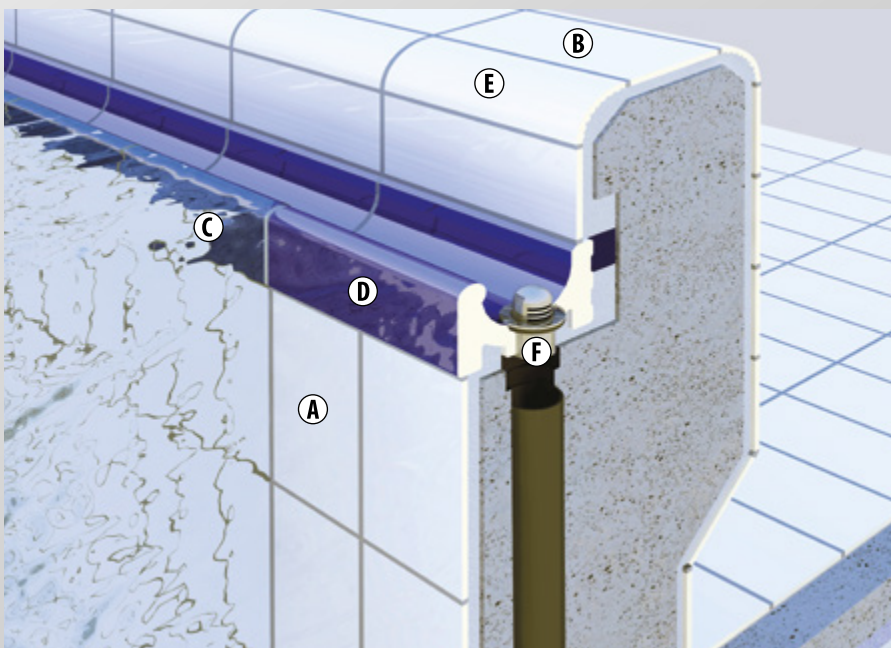

Item index | Therapy Pool System

Item description	Item no.
A Basic tile standard glazed	1200
B Basic tile standard antiskid glazed	1200 RH
C Overflow channel	5110
D Overflow channel with drainage	5111
E Radial tile, 60 mm	6450
F Drain valve, silent, 1 1/2"	5201

Features:

The small overflow channel enables the therapy guests a safe hold and also enables water flowing off. The therapist is located on the other side of the pool in an area with a dry surrounding. The shape of the pool edge is designed with radial tiles, enabling a well shaped top. This is where nice coloured designs can be set.

System Wiesbaden | large channel | low water level

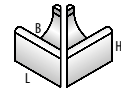
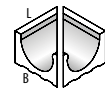
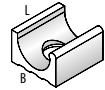
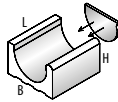
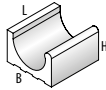

	Overflow channel large	½ Overflow channel large	Stop end set of two pcs left: 5104 right: 5106	Overflow channel with drainage $\varnothing = 85$ mm	Internal corner set of two pcs	External corner set of two pcs
Item no.	5100	5105		5101	5102	5107
Dimensions	L x B x H	L x B x H	L x B x H	L x B x H	L x B x H	L x B x H
Work size in mm	244 x 215 x 140	244 x 215 x 140	244 x 215 x 140	244 x 215 x 140	(2 x) 208 x 215 x 140	(2 x) 238 x 215 x 140
Unit	pc	pc	set	pc	set	set
Pcs/l.m. incl. joint	4	8	-	-	-	-
Approx. kg/pc	8,1	4,0	8,6	7,6	7,0	7,0
Pcs per box	1	2	1 set	1	1 set	1 set
Colour groups colours	Article no. PG	Article no. PG	Article no. PG	Article no. PG	Article no. PG	Article no. PG
VarioCOLOR programme*	66 5100 - colour no. 634	66 5105 - colour no. 602	66 5104/06 - colour no. 648	66 5101 - colour no. 648	66 5102 - colour no. 660	66 5107 - colour no. 660
Weiß semi gloss	66 5100 901 628	66 5105 901 597	66 5104/06 901 645	66 5101 901 645	66 5102 901 659	66 5107 901 659
Weiß glossy	66 5100 900 628	66 5105 900 597	66 5104/06 900 645	66 5101 900 645	66 5102 900 659	66 5107 900 659
Lichtblau glossy	66 5100 710 628	66 5105 710 597	66 5104/06 710 645	66 5101 710 645	66 5102 710 659	66 5107 710 659

SYSTEM WIESBADEN

Therapy Pool System

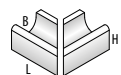

	Overflow channel small	½ Overflow channel small	Stop end set of two pcs left: 5114 right: 5116	Overflow channel with drainage $\varnothing = 50$ mm	Internal corner set of two pcs	External corner set of two pcs
Item no.	5110	5115		5111	5112	5117
Dimensions	L x B x H	L x B x H	L x B x H	L x B x H	L x B x H	L x B x H
Work size in mm	244 x 150 x 100	119 x 150 x 100	244 x 150 x 100	244 x 150 x 100	(2 x) 143 x 150 x 100	(2 x) 238 x 150 x 100
Unit	pc	pc	set	pc	set	set
Pcs/l.m. incl. joint	4	8	-	-	-	-
Approx. kg/pc	4,1	2,0	4,4	3,7	2,6	2,6
Pcs per box	2	4	1 set	2	1 set	1 set
Colour groups colours	Article no. PG	Article no. PG	Article no. PG	Article no. PG	Article no. PG	Article no. PG
VarioCOLOR programme*	66 5110 - colour no. 616	66 5115 - colour no. 587	66 5114/16 - colour no. 642	66 5111 - colour no. 642	66 5112 - colour no. 657	66 5117 - colour no. 657
Weiß semi gloss	66 5110 901 613	66 5115 901 584	66 5114/16 901 639	66 5111 901 639	66 5112 901 655	66 5117 901 655
Weiß glossy	66 5110 900 613	66 5115 900 584	66 5114/16 900 639	66 5111 900 639	66 5112 900 655	66 5117 900 655
Lichtblau glossy	66 5110 710 613	66 5115 710 584	66 5114/16 710 639	66 5111 710 639	66 5112 710 655	66 5117 710 655

THERAPY POOL

* Different price groups within the colour group are listed separately.

SYSTEM FINLAND 1

HIGH WATER LEVEL

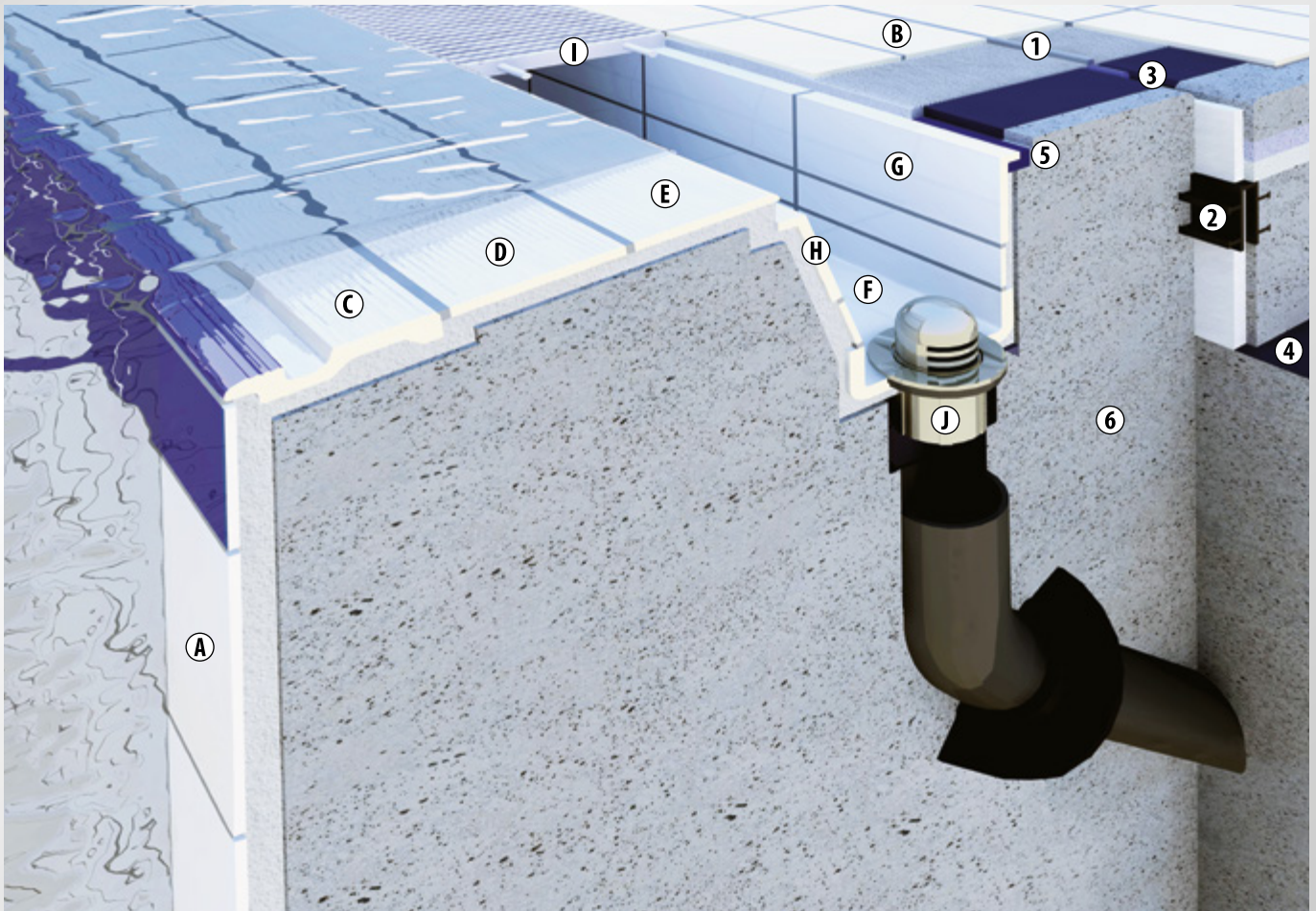

Item index | System Finland 1

Item description	Item no.
A Basic tile standard glazed	1200
B Basic tile standard antiskid glazed	1200 RH
C Hand grip tile	5730
D Small grooved tile	3130
E Small grooved tile w. safety marking	3136
F Channel with drainage	4901
G Angle tile w. grating support	9039
H Angle tile w. grating support 107°	9050
I Grating, rigid	1220
J Drain valve, silent, 2 ½"	5202

1 Expansion joint
2 Joint band
3 Expansion joint with polyethylen foam round lace
4 Slide bearing
5 Capillary break joint filling
6 Water resistant concrete

Features:

- Enlarges the "beach effect" and enables a higher water level.
- No reflecting waves from pool edge.
- The complete water level is visible therefore grants swimmers additional safety.
- The water is not blocked by a higher pool edge and therefore avoids disturbing smells or a chlorine concentration.

SYSTEM
FINLAND 1

SYSTEM FINLAND 2

HIGH WATER LEVEL

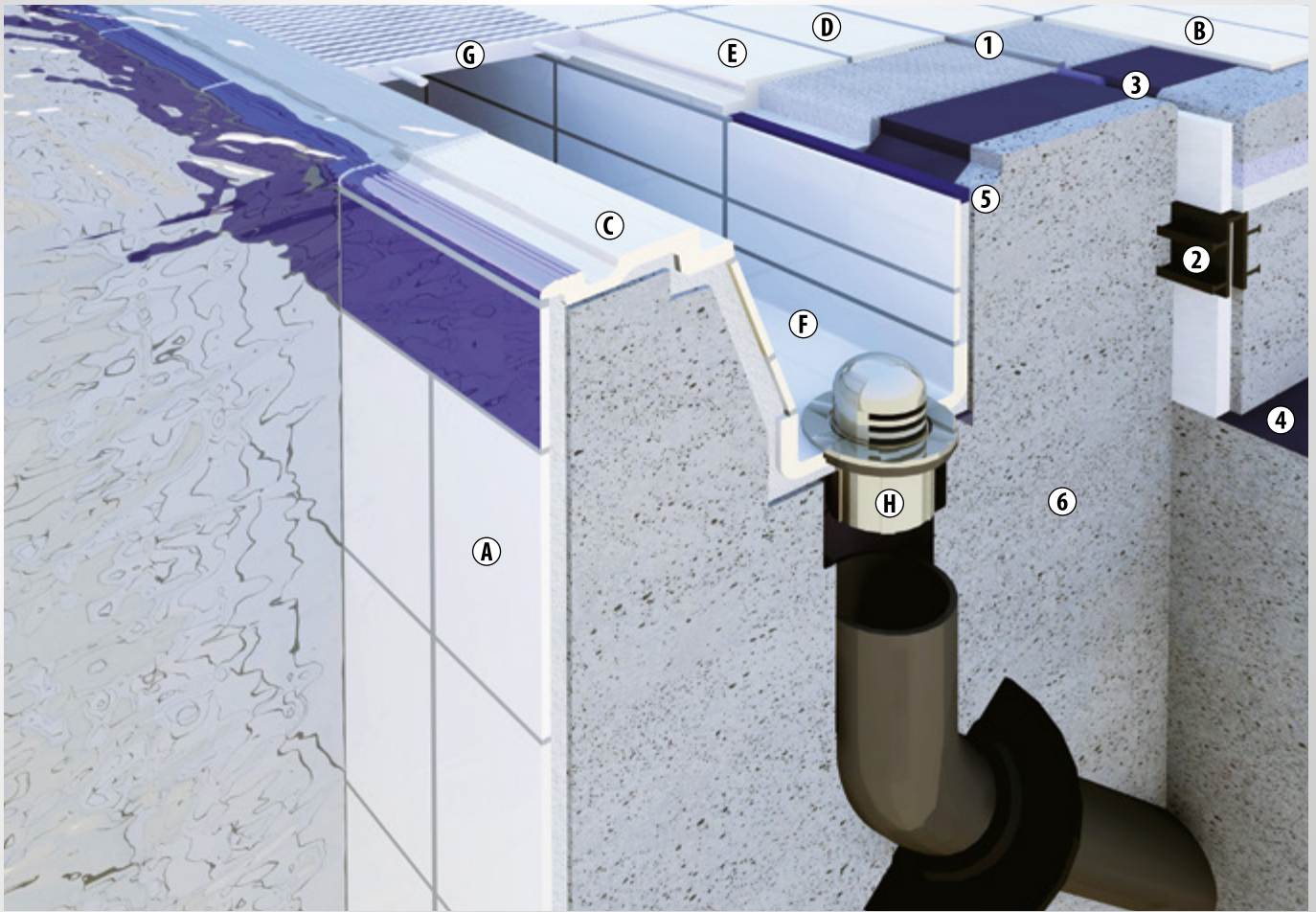

Item index | System Finland 2

Item description	Item no.
A Basic tile standard glazed	1200
B Basic tile standard antiskid glazed	1200 RH
C Hand grip tile with grating support	5810
D Small grooved tile	3130
E Edging tile with grating support	5830
F Channel with drainage	4901
G Grating, rigid	1225
H Drain valve, silent, 2 1/2"	5202

1 Expansion joint

2 Joint band

3 Expansion joint with polyethylen foam round lace

4 Slide bearing

5 Capillary break joint filling

6 Water resistant concrete

Features:

Same as System Finland 1, but with a shortened "beach-effect" as the pool edge only includes one handgrip tile with a grating support.

SYSTEM
FINLAND 2

SYSTEM FINLAND 3

HIGH WATER LEVEL

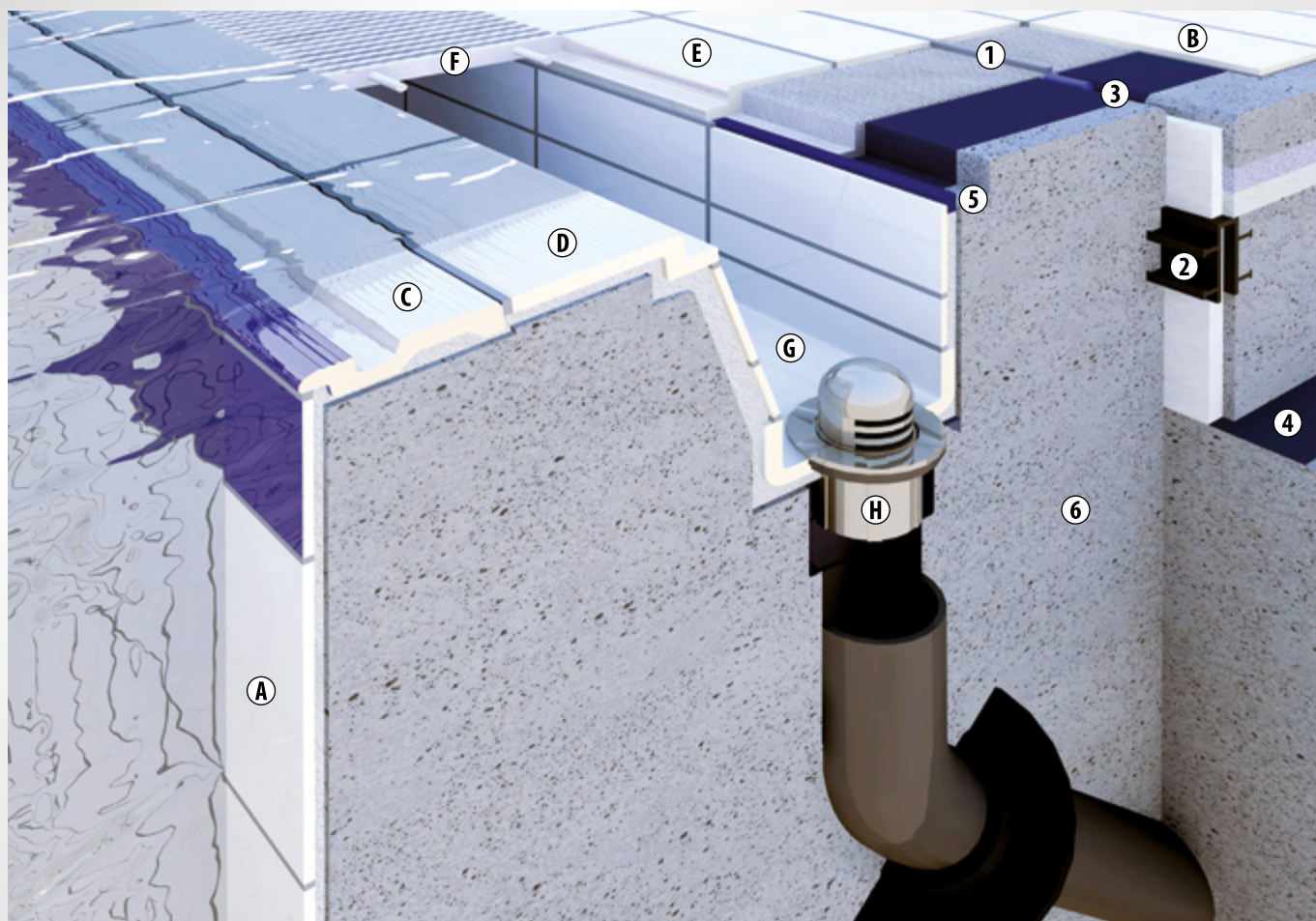

Item index | System Finland 3

Item description	Item no.
A Basic tile standard glazed	1200
B Basic tile standard antiskid glazed	1200 RH
C Hand grip tile	5730
D Grooved tile with grating support 107°	5820
E Edging tile with grating support	5830
F Grating, rigid	1225
G Channel with drainage	4901
H Drain valve, silent, 2 1/2"	5202

1 Expansion joint

2 Joint band

3 Expansion joint with polyethylen foam round lace

4 Slide bearing

5 Capillary break joint filling







6 Water resistant concrete

Features:



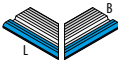

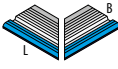
- Like the Finnish channel before but with the use of different shaped tiles for the grating support.

SYSTEM
FINLAND 3

System Finland | width 115 mm | 15 mm shaped pieces | with safety marking

							
foothold area							
safety marking [SM]							
	Hand grip tile*	Internal corner* set of two pcs	External corner* set of two pcs	Hand grip tile with grating support*	Internal corner with grating support* set of two pcs	External corner with grating support* set of two pcs	
Item no.	5730	5732	5737	5810	5812	5817	
Dimensions	L x B	L x B	L x B	L x B	L x B	L x B	
Work size in mm	244 x 115	(2 x) 108 x 115	(2 x) 238 x 115	244 x 140	(2 x) 133 x 140	(2 x) 238 x 140	
Unit	pc	set	set	pc	set	set	
Pcs/l.m. incl. joint	4	-	-	4	-	-	
Approx. kg/pc	1,04	0,56	1,6	1,3	0,56	2,0	
Pcs per box	14	1 set	1 set	8	1 set	1 set	
Colour groups colours	Article no. PG	Article no. PG	Article no. PG	Article no. PG	Article no. PG	Article no. PG	Article no. PG
Weiß antiskid "C"	66 5730 906 - colour SM 558	66 5732 906 - colour SM 609	66 5737 906 - colour SM 645	66 5810 906 - colour SM 580	66 5812 906 - colour SM 643	66 5817 906 - colour SM 651	
Graugelb antiskid "C"	66 5730 690 - colour SM 545	66 5732 690 - colour SM 588	66 5737 690 - colour SM 606	66 5810 690 - colour SM 599	66 5812 690 - colour SM 640	66 5817 690 - colour SM 646	

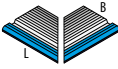
System Finland | width 150 mm | 15 mm shaped pieces | with safety marking

				
foothold area				
safety marking				
	Hand grip tile*	Internal corner* set of two pcs	External corner* set of two pcs	
Item no.	5740	5742	5747	
Dimensions	L x B	L x B	L x B	
Work size in mm	244 x 150	(2 x) 108 x 150	(2 x) 238 x 150	
Unit	pc	set	set	
Pcs/l.m. incl. joint	4	-	-	
Approx. kg/pc	1,45	0,78	2,23	
Pcs per box	14	1 set	1 set	
Colour groups colours	Article no. PG	Article no. PG	Article no. PG	
Weiß antiskid "C"	66 5740 906 - colour SM 681	66 5742 906 - colour SM 685	66 5747 906 - colour SM 687	
Graugelb antiskid "C"	66 5740 690 - colour SM 680	66 5742 690 - colour SM 684	66 5747 690 - colour SM 686	

Advice for the purchase of shaped pieces with safety markings:

- Choose the colour of the foothold area first.
- Add this colour number of the foothold area behind the item number.
- Now choose the colour of the VarioCOLOR range for the safety marking and attach it to the colour number above by adding a hyphen.

Example:

Hand grip tile 5730 - Weiß antiskid "C"









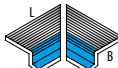

Safety marking Azurblau antiskid "C"

Article no. with additional colour no.:

66 5730 **906 - 788**

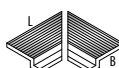
**FURTHER
COLOUR COMBINATIONS
UPON REQUEST**

System Finland | 15 mm shaped pieces | with safety marking

								
foothold area								
safety marking								
	Grooved tile* with grating support 107°	Internal corner* set of two pcs	External corner* set of two pcs	Edging tile* with grating support	Edging tile* w. grating support 83°	Internal corner* set of two pcs	External corner* set of two pcs	
Item no.	5820	5822	5827	5830	5930	5832	5837	
Dimensions	L x B	L x B	L x B	L x B	L x B	L x B	L x B	
Work size in mm	244 x 140	(2 x) 238 x 140	(2 x) 133 x 140	244 x 140	244 x 140	(2 x) 238 x 140	(2 x) 133 x 140	
Unit	pc	set	set	pc	set	set	set	
Pcs/l.m. incl. joint	4	-	-	4	4	-	-	
Approx. kg/pc	1,2	2,0	1,0	1,1	1,2	2,0	1,0	
Pcs per box	8	1 set	1 set	9	9	1 set	1 set	
Colour groups colours	Article no. PG	Article no. PG	Article no. PG	Article no. PG	Article no. PG	Article no. PG	Article no. PG	Article no. PG
Weiß antiskid "C"	66 5820 906 - colour SM 580	66 5822 906 - colour SM 651	66 5827 906 - colour SM 651	66 5830 906 579	66 5930 906 614	66 5832 906 641	66 5837 906 633	
Graugelb antiskid "C"	66 5820 690 - colour SM 599	66 5822 690 - colour SM 646	66 5827 690 - colour SM 646	66 5830 690 573	66 5930 690 604	66 5832 690 633	66 5837 690 621	

* Foothold area achieves slip rating "C" by grooves on tile surface.

SYSTEM BERLIN

HIGH WATER LEVEL

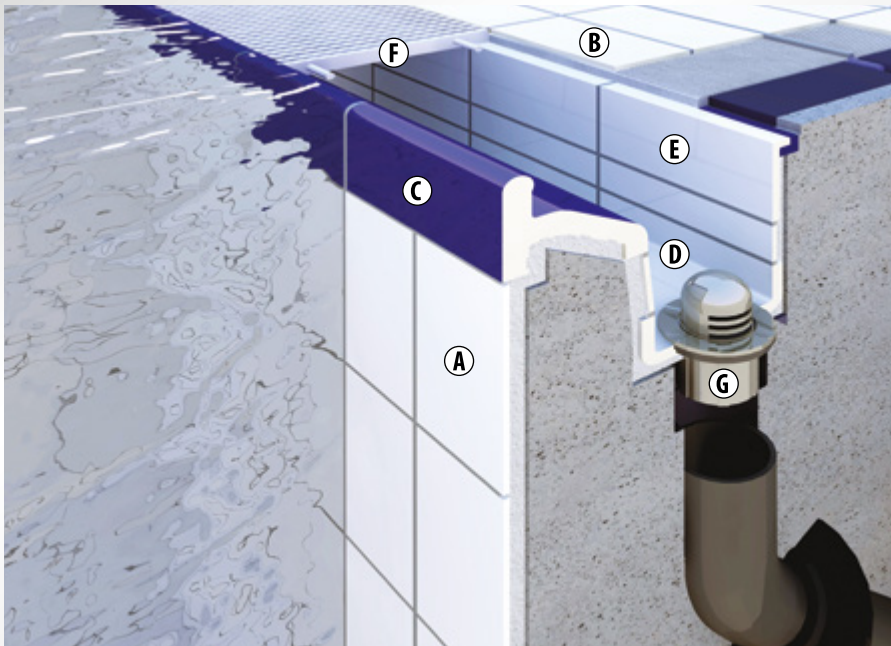

Item index | System Berlin

Item description	Item no.
A Basic tile standard glazed	1200
B Basic tile standard antiskid glazed	1200 RH
C Overflow channel	5150
D Channel with drainage	4901
E Angle tile w. grating support	9039
F Grating, rigid	1220
G Drain valve, silent, 2 1/2"	5202

Features:

Due to the slope inside the channel, noises and fumes are reduced. The edge of the overflow channel is equal to the Wiesbaden channel.

SYSTEM ZÜRICH

HIGH WATER LEVEL

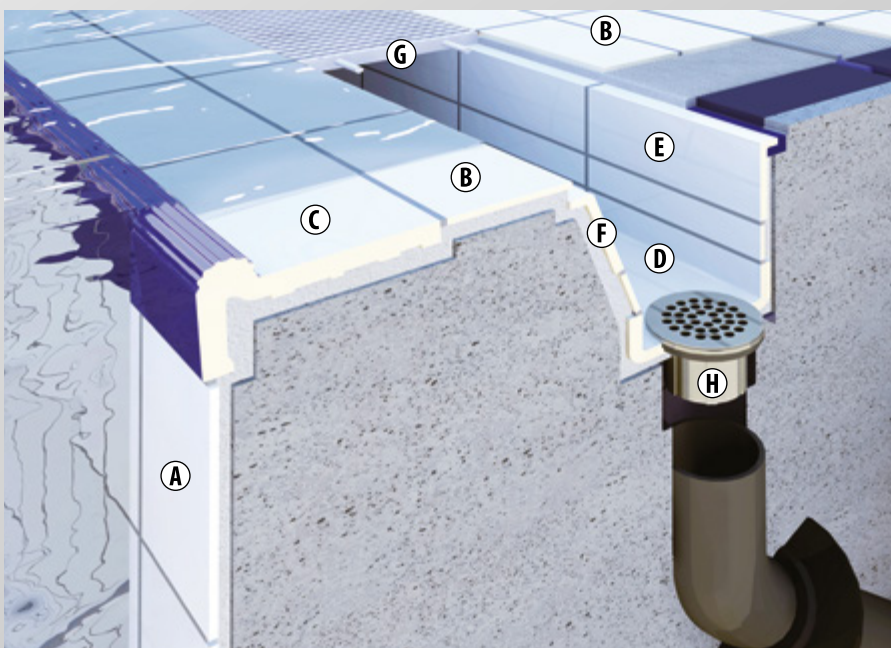

Item index | System Zürich

Item description	Item no.
A Basic tile standard glazed	1200
B Basic tile standard antiskid glazed	1200 RH
C Pool edging tile	5450
D Channel with drainage	4901
E Angle tile w. grating support	9039
F Angle tile w. grating support 107°	9050
G Grating, rigid	1225
H Drain valve, 2 1/2"	5102

Features:

- The water level is on or above the pool surrounding.
- The Zürich channel offers a very good hand grip for swimmers on the pool edge.
- The complete water level is visible and swimmers can be guarded well.

System Berlin

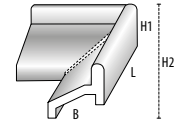
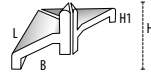
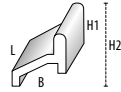
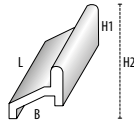

	Overflow channel	½ Overflow channel	Internal corner set of two pcs	External corner set of two pcs
Item no.	5150	5155	5152	5157
Dimensions	L x B x H1 H2	L x B x H1 H2	L x B x H	L x B x H1 H2
Work size in mm	244 x 160 x 115 150	119 x 160 x 115 150	(2 x) 158 x 160 x 115 150	(2 x) 244 x 160 x 115 150
Unit	pc	pc	set	set
Pcs/l.m. incl. joint	4	8	-	-
Approx. kg/pc	7,0	3,5	6,5	12,0
Pcs per box	1	2	1 set	1 set
Colour groups colours	Article no. PG	Article no. PG	Article no. PG	Article no. PG
VarioCOLOR programme*	66 5150 - colour no. 646	66 5155 - colour no. 612	66 5152 - colour no. 658	66 5157 - colour no. 672
Weiß semi gloss	66 5150 901 639	66 5155 901 599	66 5152 901 656	66 5157 901 671
Weiß glossy	66 5150 900 639	66 5155 900 599	66 5152 900 656	66 5157 900 671
Lichtblau glossy	66 5150 710 639	66 5155 710 599	66 5152 710 656	66 5157 710 671

* Different price groups within the colour group are listed separately.

SYSTEM BERLIN

SYSTEM ST. MORITZ ELEVATED POOL EDGE SYSTEM

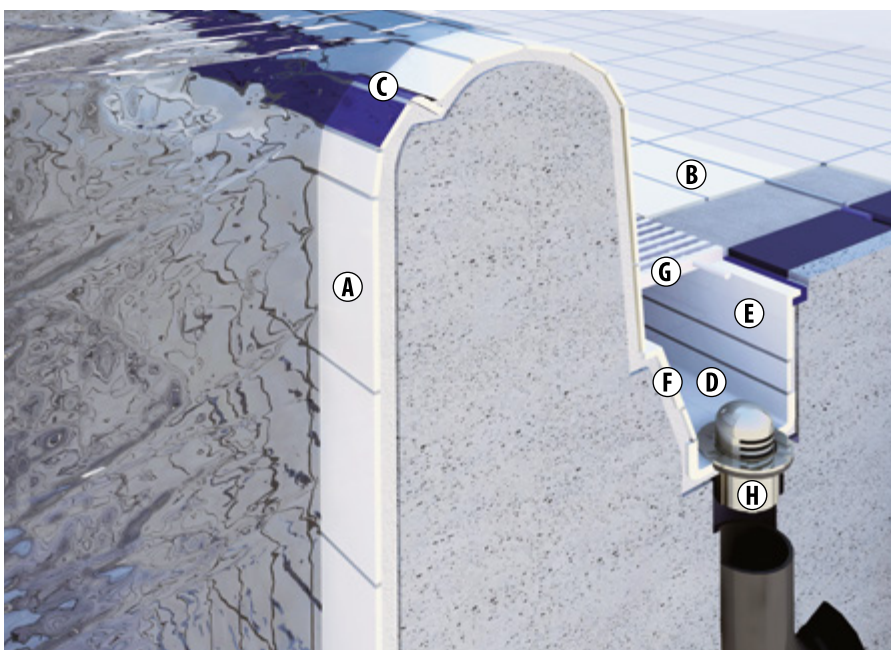

Item index | System St. Moritz

Item description	Item no.
A Basic tile standard glazed	1200
B Basic tile standard antiskid glazed	1200 RH
C Basic tile, long edge rounded	1200 LR
D Channel with drainage	4901
E Angle tile w. grating support	9039
F Angle tile w. grating support 107°	9050
G Grating, rigid	1225
H Drain valve, silent, 2 ½"	5202

Features:

- Lower foundation depth with less excavation work.
- Swimming over the level of the pool surrounding enables swimmers to have a good overall view.
- Variable sizes of channels are possible.

SYSTEM SKIMMER | FOR FLAT POOL EDGES AND SURROUNDINGS

ALSO FOR SYSTEM WIESBADEN AND SYSTEM ZÜRICH WITH LOW WATER LEVEL

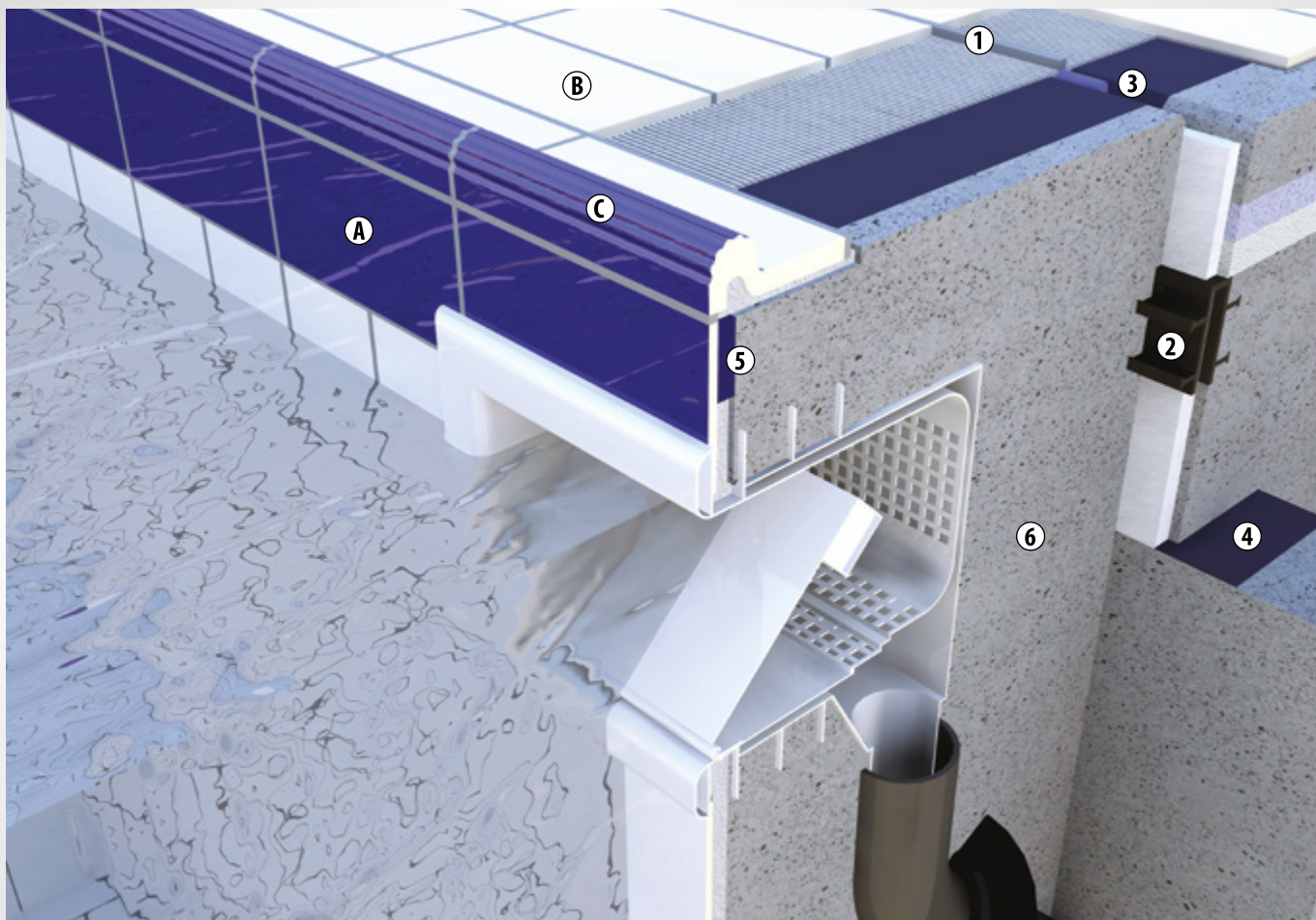

Item index | System Skimmer

Item description	Item no.
A Basic tile standard glazed	1200
B Basic tile standard antiskid glazed	1200 RH
C Pool edging tile	5750

1 Expansion joint
2 Joint band
3 Expansion joint with polyethylen foam round lace
4 Slide bearing
5 Capillary break joint filling
6 Water resistant concrete

SYSTEM SKIMMER

System Skimmer | shaped pieces with vertical front/hand grip

foothold area

vertical front/hand grip [VF]

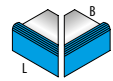
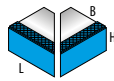

	Pool edging tile with vertical front	Internal corner set of two pcs	External corner with vertical front set of two pcs	Pool edging tile with vertical front/hand grip	Internal corner with hand grip set of two pcs	External corner with vertical front/hand grip set of two pcs
Item no.	5400	5402	5407	5450	5452	5457
Dimensions	L x B x H	L x B	L x B x H	L x B x H	L x B	L x B x H
Work size in mm	244 x 180 x 100	(2 x) 173 x 180	(2 x) 238 x 180 x 100	244 x 180 x 115	(2 x) 173 x 180	(2 x) 238 x 180 x 115
Unit	pc	set	set	pc	set	set
Pcs/l.m. incl. joint	4	-	-	4	-	-
Approx. kg/pc	3,3	1,6	4,8	3,3	1,7	4,9
Pcs per box	3	4 sets	1 set	3	2 sets	1 set
Colour groups colours	Article no. PG	Article no. PG	Article no. PG	Article no. PG	Article no. PG	Article no. PG
Weiß, antiskid	66 5400 906 - colour VF 620	66 5402 906 - colour VF 635	66 5407 906 - colour VF 663	66 5450 906 - colour VF 633	66 5452 906 - colour VF 636	66 5457 906 - colour VF 669
Graugelb antiskid	66 5400 690 - colour VF 617	66 5402 690 - colour VF 630	66 5407 690 - colour VF 662	66 5450 690 - colour VF 628	66 5452 690 - colour VF 630	66 5457 690 - colour VF 668

System Skimmer | shaped pieces with safety marking

foothold area

safety marking [SM]

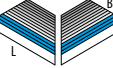
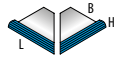

	Pool edging tile [also available in half size format]	Internal corner set of two pcs	External corner set of two pcs	Edging tile* with safety marking	Internal corner* set of two pcs	External corner* set of two pcs
Item no.	5750	5752	5757	5480	5482	5487
Dimensions	L x B x H	L	L x B x H	L x B x H	L	L x B x H
Werkmaß in mm	244 x 115 x 45	(2 x) 115	(2 x) 238 x 115 x 45	244 x 118 x 50	(2 x) 115	(2 x) 238 x 118 x 50
Unit	pc	set	set	pc	set	set
Pcs/l.m. incl. joint	4	-	-	4	-	-
Approx. kg/pc	1,2	0,53	1,70	0,9	0,52	1,8
Pcs per box	10	1 set	1 set	9	1 set	1 set
Colour groups colours	Article no. PG	Article no. PG	Article no. PG	Article no. PG	Article no. PG	Article no. PG
Weiß, antiskid	66 5750 906 - colour SM 583	66 5752 906 - colour SM 620	66 5757 906 - colour SM 652	66 5480 906 - colour SM 578	66 5482 906 - colour SM 620	66 5487 906 - colour SM 652
Graugelb antiskid	66 5750 690 - colour SM 568	66 5752 690 - colour SM 617	66 5757 690 - colour SM 649	66 5480 690 - colour SM 570	66 5482 690 - colour SM 617	66 5487 690 - colour SM 649

* Foothold area achieves slip rating "C" by grooves on tile surface.

System Skimmer | surface to be covered with tiles | shaped pieces

foothold area

vertical front/hand grip [VF]



	Pool edging tile with vertical front	Internal corner set of two pcs	External corner set of two pcs
Item no.	5460	5462	5467
Dimensions	L x B x H	L x B x H	L x B x H
Werkmaß in mm	244 x 180 x 115	(2 x) 173 x 180 x 25	(2 x) 238 x 180 x 115
Unit	pc	set	set
Pcs/l.m. incl. joint	4	-	-
Approx. kg/pc	3,49	1,5	6,6
Pcs per box	2	2 sets	1 set
Colour groups colours	Article no. PG	Article no. PG	Article no. PG
Graugelb unglazed	66 5460 690 - colour VF 633	66 5462 690 - colour VF 635	66 5467 690 - colour VF 663

Advice for the purchase of shaped pieces with safety marking or grip support:

- Choose the colour of the foothold area first.
- Add this colour number of the foothold area behind the item number.
- Now choose the colour of the VarioCOLOR range for the safety marking or the grip support and attach it to the colour above by adding a hyphen.

Example:

Pool edging tile 5400 - **Weiß antiskid "B"**

grip support - Lichtblau glossy

Article no. with additional colour indications: 66 5400 **906 - 710**

**FURTHER
COLOUR COMBINATIONS
UPON REQUEST**

RADIAL TILES & COVERED TILE SYSTEMS

EXAMPLES FOR SYSTEM COMBINATIONS



RADIAL TILES & COVERED TILE SYSTEMS

Radial tiles | 7,5 mm shaped pieces | radius 30 mm [average radius approx. 30 mm, ext. radius depending on the joint width up to 40 mm]

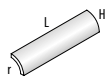

	Radial tile	External corner 3	External corner 2	Internal corner
Item no.	9450	9453	9454	9452
Dimensions	L x H r	r	L x B r	L x B r
Work size in mm	244 x 30 r ca. 30	r ca. 30	40 x 40 r ca. 30	70 x 70 r ca. 30

	pc	pc	pc	pc
Unit	pc	pc	pc	pc
Pcs/l.m. incl. joint	4	-	-	-
Approx. kg/pc	0,30	0,09	0,09	0,07
Pcs per box	50	-	-	-

Colour groups colours	Article no. PG	Article no. PG	Article no. PG	Article no. PG
VarioCOLOR semi gloss*	66 9450 - colour no. 520	66 9453 - colour no. 532	66 9454 - colour no. 532	66 9452 - colour no. 560
VarioCOLOR antiskid "B/C"*	66 9450 - colour no. 525	66 9453 - colour no. 532	66 9454 - colour no. 532	66 9452 - colour no. 560
Weiß semi gloss	66 9450 901 512	66 9453 901 528	66 9454 901 528	66 9452 901 555
Weiß glossy	66 9450 900 512	66 9453 900 528	66 9454 900 528	66 9452 900 555
Graugelb unglazed	66 9450 690 512	66 9453 690 528	66 9454 690 528	66 9452 690 555



Radial tiles | 7,5 mm shaped pieces | radius 60 mm [average radius approx. 60 mm, ext. radius depending on the joint width up to 70 mm]

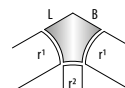
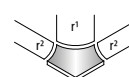
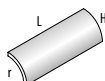

	Radial tile	External corner 3	External corner 2	External corner K8	Internal corner R86
Item no.	6450	6453	6454	6457	6462
Dimensions	L x H r	r	r	r ¹ x r ²	L x B x r ¹ x r ²
Work size in mm	244 x 60 r approx. 60	r approx. 60	r approx. 60	approx. 60 x approx. 30	90 x 90 x approx. 60 x approx. 30

	pc	pc	pc	pc	pc
Unit	pc	pc	pc	pc	pc
Pcs/l.m. incl. joint	4	-	-	-	-
Approx. kg/pc	0,40	0,10	0,10	0,10	0,10
Pcs per box	36	-	-	-	-

Colour groups colours	Article no. PG	Article no. PG	Article no. PG	Article no. PG	Article no. PG
VarioCOLOR semi gloss*	66 6450 - colour no. 538	66 6453 - colour no. 559	66 6454 - colour no. 559	66 6457 - colour no. 574	66 6462 - colour no. 574
VarioCOLOR antiskid "B/C"*	66 6450 - colour no. 539	66 6453 - colour no. 559	66 6454 - colour no. 559	66 6457 - colour no. 574	66 6462 - colour no. 574
Weiß semi gloss	66 6450 901 534	66 6453 901 553	66 6454 901 553	66 6457 901 569	66 6462 901 569
Weiß glossy	66 6450 900 534	66 6453 900 553	66 6454 900 553	66 6457 900 569	66 6462 900 569
Graugelb unglazed	66 6450 690 534	66 6453 690 553	66 6454 690 553	66 6457 690 569	66 6462 690 569



* Different price groups within the colour group are listed separately.

SYSTEM COMBINATIONS

COVERED AND RADIAL TILES SYSTEM 30 MM

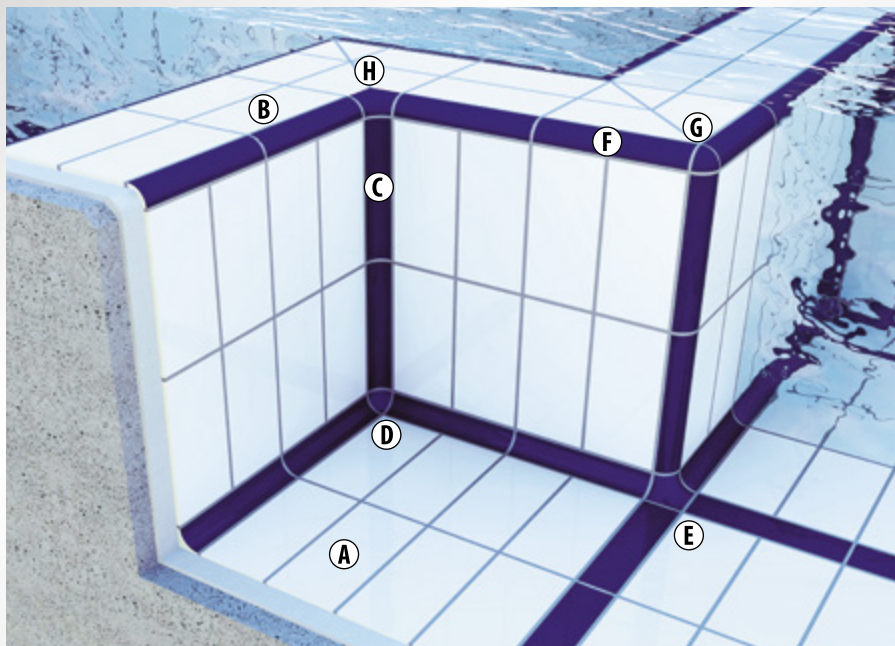

Item index | system combination 30 mm

Item description	Item no.
A Basic tile standard glazed	1200
B Basic tile standard antiskid glazed	1200 RH
C Covered tile	4100
D Internal corner to covered tile, for three sides connected	4102
E External corner to covered tile, with connection to radial tiles 30 mm	4107
F Radial tile, radius 30 mm	9450
G External corner to radial tiles, with three sides connected	9453
H Internal corner to radial tiles 30 mm, with connection to covered tile	9452

SYSTEM COMBINATIONS

COVERED TILES AND RADIAL TILES SYSTEM 60 MM

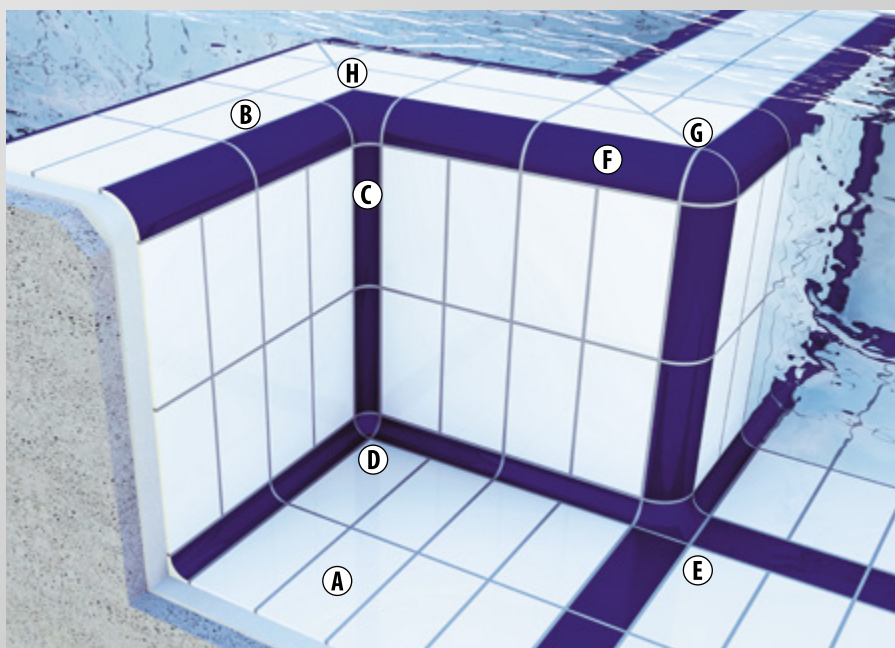

Item index | system combination 60 mm

Item description	Item no.
A Basic tile standard glazed	1200
B Basic tile standard antiskid glazed	1200 RH
C Covered tile	4100
D Internal corner to covered tile, for three sides connected	4102
E External corner to covered tile, with connection to radial tiles 60 mm	6457
F Radial tile, radius 60 mm	6450
G External corner to radial tiles 60 mm, for three sides connected	6453
H Internal corner to radial tiles 60 mm, with connection to covered tile	6462

Coved skirting system | 6,5 mm shaped pieces

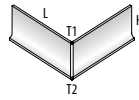
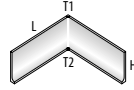

	Coved skirting tile	Internal corner set of two pcs	External corner set of two pcs
Item no.	4000	4002	4007
Dimensions	L x H x T1 T2	L x H x T1 T2	L x H x T1 T2
Work size in mm	244 x 100 x 6,5 16,5	(2 x) 244 x 100 x 6,5 16,5	(2 x) 244 x 100 x 6,5 16,5

Unit	pc	set	set
Pcs/l.m. incl. joint	4	-	-
Approx. kg/pc	0,56	1,1	1,1
Pcs per box	20	10 sets	10 sets

Colour groups colours	Article no. PG	Article no. PG	Article no. PG
VarioCOLOR semi gloss*	66 4000 - colour no. 523	66 4002 - colour no. 552	66 4007 - colour no. 552
VarioCOLOR unglazed	66 4000 - colour no. 764	66 4002 - colour no. 765	66 4007 - colour no. 765
Weiß semi gloss	66 4000 901 507	66 4002 901 546	66 4007 901 546
Weiß glossy	66 4000 900 507	66 4002 900 546	66 4007 900 546
Graugelb unglazed	66 4000 690 507	66 4002 690 546	66 4007 690 546



Coved tile system | 7,5 mm shaped pieces

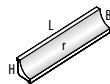
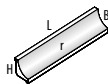

	Coved tile	Coved stop end	Coved corner tile left	Coved corner tile right	External corner for coved skirting	Internal corner
Item no.	4100	4101	4104	4106	4107	4102
Dimensions	L x B x H r	L x B x H r	L x B x H	L x B x H	L x B r	r
Work size in mm	244 x 40 x 40 r = 30	244 x 40 x 40 r = 30	145 x 40 x 40	145 x 40 x 40	70 x 70 r = 30	r = 30

Unit	pc	pc	pc	pc	pc	pc
Pcs/l.m. incl. joint	4	-	-	-	-	-
Approx. kg/pc	0,36	0,36	0,22	0,22	0,15	0,05
Pcs per box	48	-	-	-	-	-

Colour groups colours	Article no. PG	Article no. PG	Article no. PG	Article no. PG	Article no. PG	Article no. PG
VarioCOLOR semi gloss*	66 4100 - colour no. 517	66 4101 - colour no. 532	66 4104 - colour no. 530	66 4106 - colour no. 530	66 4107 - colour no. 552	66 4102 - colour no. 530
Weiß semi gloss	66 4100 901 507	66 4101 901 527	66 4104 901 528	66 4106 901 528	66 4107 901 546	66 4102 901 528
Weiß glossy	66 4100 900 507	66 4101 900 527	66 4104 900 528	66 4106 900 528	66 4107 900 546	66 4102 900 528
Graugelb unglazed	66 4100 690 507	66 4101 690 527	66 4104 690 528	66 4106 690 528	66 4107 690 546	66 4102 690 528



* Different price groups within the colour group are listed separately.

GROOVED TILES & SPECIAL TILES

FOR STEPS LEADING INTO WATER OR UNDER WATER
AND IN ADDITION TO THE POOL EDGE SYSTEM FINLAND



Grooved tiles & special tiles | 10 mm shaped pieces [also available in 15 mm thickness, surcharge 20 %]

foothold area
safety marking [SM]

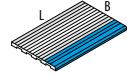
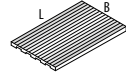
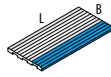
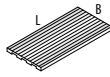

	Small grooved tile*	Small grooved tile, long edge rounded with safety marking*	Large grooved tile*	Large grooved tile, long edge rounded with safety marking*
Item no.	3130	3136	3190	3196
Dimensions	L x B	L x B	L x B	L x B
Work size in mm	244 x 119	244 x 119	244 x 150	244 x 150
Unit	pc	pc	pc	pc
Pcs/l.m. incl. joint Pc/m ²	32	4	26	4
Approx. kg/pc	0,53	0,51	0,8	0,79
Pcs per box	23	30	16	24
Colour groups colours	Article no. PG	Article no. PG	Article no. PG	Article no. PG
VarioCOLOR semi gloss	66 3130 - colour no. 508	-	66 3190 - colour no. 535	-
Weiß antiskid "C"	66 3130 906 506	66 3136 906 - colour SM 530	66 3190 906 530	66 3196 906 - colour SM 546
Graugelb antiskid "C"	66 3130 690 501	66 3136 690 - colour SM 509	66 3190 690 511	66 3196 690 - colour SM 526
Shaped pieces rounded	Rounded edges PG	Rounded edges PG	Rounded edges PG	Rounded edges PG
	short rounded edge - KR 509	short rounded edge - KR 538	short rounded edge - KR 538	short rounded edge - KR 552
		corner rounded right - ERR / left - ERL 538		corner rounded right - ERR / left - ERL 552

* Also available in half size format [price 80 % of full size format]. | Foothold area achieves slip rating "C" by grooves on tile surface.

Grooved tiles & special tiles | 10 mm shaped pieces

foothold area
safety marking [SM]

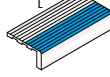
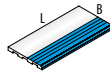

	Safety strip tile	Step tile, long edge rounded with safety marking*	Angle step tile with grooved surface*
Item no.	3195	4710	5700
Dimensions	L x B	L x B	L x B x H
Work size in mm	244 x 56	244 x 115	244 x 115 x 25
Unit	pc	pc	pc
Pcs/l.m. incl. joint Pc/m ²	4	4	4
Approx. kg/pc	0,4	0,4	0,84
Pcs per box	44	44	10
Colour groups colours	Article no. PG	Article no. PG	Article no. PG
Weiß antiskid "C"	-	66 4710 906 - colour SM 530	66 5700 906 - colour SM 564
Graugelb antiskid "C"	66 3195 - colour no. 524	66 4710 690 - colour SM 509	66 5700 690 - colour SM 552
Weiß antiskid "C"*	-	-	66 5700 906 540
Graugelb antiskid "C"*	-	-	66 5700 690 535

* Foothold area achieves slip rating "C" by grooves on tile surface.

Instructions for ordering shaped pieces rounded:

Please add the following abbreviations to the article number:

Short rounded edge: **KR** | Long rounded edge: **LR**

Corner rounded left: **ERL** | Corner rounded right: **ERR**

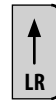

Advice for the purchase of shaped pieces with safety marking or grip support:

- Choose the colour of the foothold area .
- Add this colour number of the foothold area behind the article number.
- Now choose the colour of the VarioCOLOR range for the safety marking or the grip support and attach it to the colour of the foothold area by adding a hyphen.

Example:

Small grooved tile 3136 - foothold area: **Weiß antiskid "C"**

Safety marking: **Azurlblau antiskid "C"**

Article number with additional colour indications: 66 3136 **906** - 788

**FURTHER
COLOUR COMBINATIONS
UPON REQUEST**

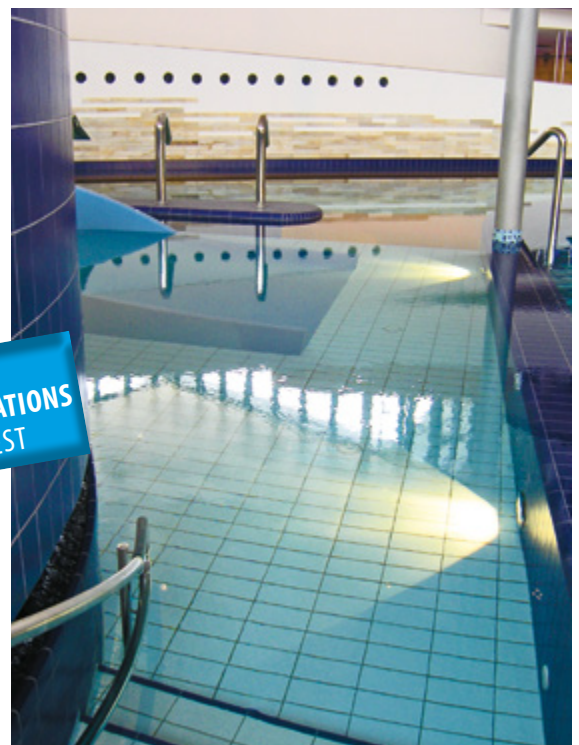

SPECIAL TILES | LADDER STEP TILES | LETTERING TILES

FOR TURNING AREAS, REST LEDGES & STAIR TREADS



SPECIAL TILES
LADDER STEP TILES

Special tiles | 10 mm shaped pieces [also available in 15 mm thickness, surcharge 20 %]

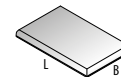
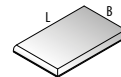
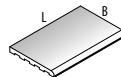
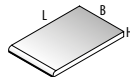
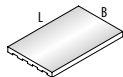
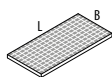

	Diamond shaped tile [only available in 10 mm thickness]	Large tile*	Large tile short edge rounded	Large tile long edge rounded*	Large tile corner left rounded	Large tile corner right rounded
Item no.	3170	1150	1155	1156	1157	1158
Dimensions	L x B	L x B	L x B	L x B	L x B	L x B
Work size in mm	244 x 119	244 x 150	244 x 150	244 x 150	244 x 150	244 x 150

Unit	pc	pc	pc	pc	pc	pc
Pcs/l.m. incl. joint Pc/m ²	32	26	6,5	4	-	-
Approx. kg/pc	0,56	0,84	0,82	0,80	0,78	0,78
Pcs per box	30	24	24	24	24	24

Colour groups colours	Article no. PG	Article no. PG	Article no. PG	Article no. PG	Article no. PG	Article no. PG
VarioCOLOR semi gloss**	66 3170 - colour no. 509	66 1150 - colour no. 503	66 1155 - colour no. 513	66 1156 - colour no. 513	66 1157 - colour no. 513	66 1158 - colour no. 513
Weiß semi gloss	66 3170 901 507	66 1150 901 502	66 1155 901 506	66 1156 901 506	66 1157 901 506	66 1158 901 506
Weiß glossy	66 3170 900 507	66 1150 900 502	66 1155 900 506	66 1156 900 506	66 1157 900 506	66 1158 900 506
Lichtblau glossy	66 3170 710 507	66 1150 710 502	66 1155 710 506	66 1156 710 506	66 1157 710 506	66 1158 710 506
Weiß antiskid	66 3170 906 507	66 1150 906 504	66 1155 906 508	66 1156 906 508	66 1157 906 508	66 1158 906 508
Graugelb unglazed	66 3170 690 505	66 1150 690 501	66 1155 690 505	66 1156 690 505	66 1157 690 505	66 1158 690 505

* Also available in half size format [price 80 % of full size format]. | ** Different price groups within the colour group are listed separately.

Lettering tiles | 10 or 7,5 mm | Digitally printed or water-jet cut

WT 1,20 m

WT 1,20 m

	Lettering tile digitally printed	Lettering tile water-jet cut
Item no.	1100	1100
Dimensions	L x B x H	L x B x H
Work size in mm	240 x 115 x 10 244 x 119 x 7,5	240 x 115 x 10 244 x 119 x 7,5

Unit	pc	pc
Pcs/l.m. incl. joint Pc/m ²	4	4
Approx. kg/pc	0,6 0,49	0,6 0,49
Pcs per box	-	-

Colour groups colours	Article no. PG	Article no. PG
Weiß antiskid "C"	-	66 1100 906 - VarioCOLOR colour no. 649
Graugelb unglazed	66 1100 690 649	66 1100 690 - VarioCOLOR colour no. 649

Advice for the purchase of lettering tiles:

- The lettering tiles are produced according to order. The price depends on the size of the letters and the required surface.
- Inscription of selected shaped pieces is also possible.
- Please request price for creative versions.



Ladder step tiles

foothold area
antiskid "C"
front side

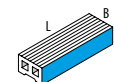
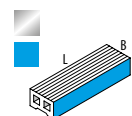

Ladder step tile long*	Ladder step tile short*
Item no.	5565
Dimensions	L x B x H
Work size in mm	280 x 80 x 50

pc	pc
3,66	4,00
1,6	1,49
8	8

Article no. PG	Article no. PG
66 5565 906 - colour no. 612	66 5560 906 - colour no. 612
66 5565 690 - colour no. 607	66 5560 690 - colour no. 607

* Foothold area achieves slip rating "C" by grooves on tile surface.

Advice for the purchase of ladder step tiles:

- Always choose a foothold area on top in white or grey-yellow antiskid "C".
- Now choose the colour of the VarioCOLOR range for the front section and attach it to the colour above by adding a hyphen.

Example:

Ladder step tile 5565

Foothold area on top: Weiß antiskid "C"

Front section VarioCOLOR Lichtblau glossy

Article no. with additional colour indications: 66 5565 **906** - 710

SPECIAL TILES
FOR CHANNELS AND DRAINS

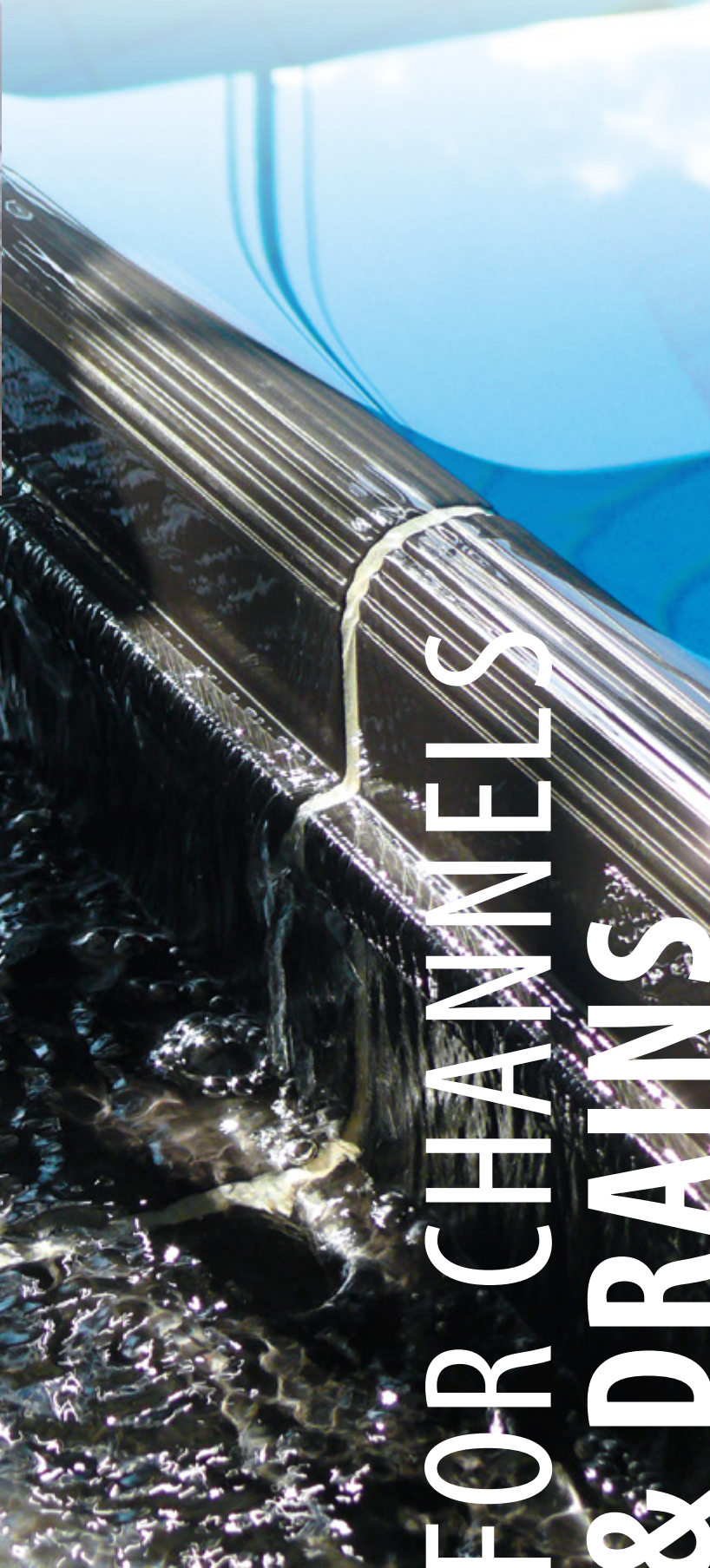

FOR CHANNELS
& DRAINS

Special tiles for channels and drains | 15 mm

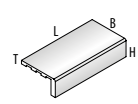
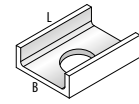
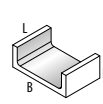
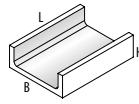
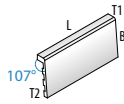
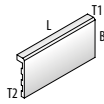

	Angle tile with grating support	Angle tile with grating support 107°	Channel for channel cladding	½ Channel for channel cladding	Channel with drainage for channel cladding ø = 85 mm	External angle tile
Item no.	9039	9050	4900	4905	4901	4822
Dimensions	L x B x T1 x T2	L x B x H x T1 T2	L x B x H inside: 150 mm	L x B x H inside: 150 mm	L x B x H inside: 150 mm	L x B x H x T
Work size in mm	244 x 115 x 25 x 10	244 x 115 x 25 x 10	244 x 180 x 65	119 x 180 x 65	244 x 180 x 65	244 x 115 x 52 x 10
Unit	pc	pc	pc	pc	pc	pc
Pcs/l.m. incl. joint pc/m²	4	4	4	8	4	4
Approx. kg/pc	0,76	0,76	2,3	1,15	2,0	0,9
Pcs per box	16	16	4	8	-	10
Colour groups colours	Article no. PG	Article no. PG	Article no. PG	Article no. PG	Article no. PG	Article no. PG
Weiß semi gloss	66 9039 901 524	66 9050 901 531	66 4900 901 555	66 4905 901 547	66 4901 901 595	44 4822 901 527
Weiß glossy	66 9039 900 524	66 9050 900 531	66 4900 900 555	66 4905 900 547	66 4901 900 595	44 4822 900 527

Special tiles for waste water channels

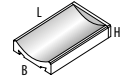
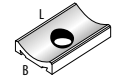
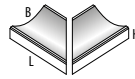
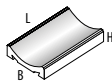

	Gutter tile for open channel systems	½ Gutter tile for open channel systems	Mitred pair set of two pcs	Drainage for 1 ½" ø = 50 mm	Stop end
Item no.	4500	4505	4502	4501	4504
Dimensions	L x B x H	L x B x H	L x B x H	L x B x H	L x B x H
Work size in mm	244 x 150 x 35	119 x 150 x 35	(2 x) 238 x 150 x 35	244 x 150 x 35	244 x 150 x 35
Unit	pc	pc	set	pc	pc
Pcs/l.m. incl. joint pc/m²	4	8	-	-	-
Approx. kg/pc	1,6	0,8	1,3	1,4	1,7
Pcs per box	8	16	1 set	8	8
Colour groups colours	Article no. PG	Article no. PG	Article no. PG	Article no. PG	Article no. PG
Weiß antiskid "C"	66 4500 908 542	66 4505 908 536	66 4502 908 600	66 4501 908 600	66 4504 908 600
Graugelb unglazed	66 4500 690 536	66 4505 690 529	66 4502 690 596	66 4501 690 596	66 4504 690 596



ACCESSORIES

GRATINGS FOR CHANNELS & DRAIN VALVES



SWIMMING POOL
ACCESSORIES

Gratings for channels | height: 22 mm

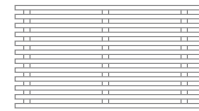
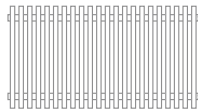

	Grating, rigid standard length 885 mm	Grating, "roll-up" in right angle to pool edge standard length 2000-3000 mm	Parallel gratings, rigid standard length 2000 mm
Benefits	economical	easy to handle	excellent water flow off
Grating width	Article no. PG/l.m.	Article no. PG/l.m.	Article no. PG/l.m.
150 mm	76 1215 - colour no. 904	76 3215 - colour no. 909	76 2215 - colour no. 910
185 mm	76 1218 - colour no. 904	76 3218 - colour no. 912	76 2218 - colour no. 912
200 mm	76 1220 - colour no. 904	76 3220 - colour no. 912	76 2220 - colour no. 912
250 mm	76 1225 - colour no. 906	76 3225 - colour no. 914	76 2225 - colour no. 916
300 mm	76 1230 - colour no. 908	76 3230 - colour no. 917	76 2230 - colour no. 920
350 mm	76 1235 - colour no. 910	-	-
400 mm	76 1240 - colour no. 922	-	-
Corners	Article no. PG extra charge for corner	Article no. PG extra charge for corner	Article no. PG extra charge for corner
Rigid corner [90°]	-	76 3201 - colour no. 914	-
Mitred corner [75-120°]	76 1202 - colour no. 914	76 3202 - colour no. 914	76 2202 - colour no. 914
Radius	Article no. PG extra charge/l.m.	Article no. PG extra charge/l.m.	Article no. PG extra charge/l.m.
up to 300 mm width	76 1203 - colour no. 924	76 3203 - colour no. 924	upon request
up to 500 mm width	76 1205 - colour no. 930	76 3205 - colour no. 930	upon request

COLOURS FOR GRATINGS



- 901 White**
- 921 Grey**
- 271 Yellow**
- 131 Beige**



Abb. 1
Rigid corner [90°]



Abb. 2
Mitred corner [75-120°]

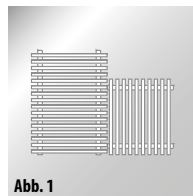

Abb. 3
Mitred corner [75-120°],
for parallel gratings

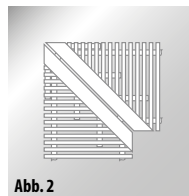

Abb. 4
Radius
[300 up to 500 mm width]

Important advice for the purchase of gratings for channels:

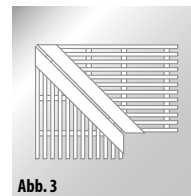
- Please add the colour no. to the item number.
- Covering gratings are specially produced for projects in order to fit. Therefore exact measurements are required.
- Custom made curved-gratings and corners can be manufactured on behalf of stencils on paper for example.
- The price groups [PG] listed on this page refer to the displayed items in the standard colours. Individual colours, sizes and special corners are available upon request.
- Please consider that additionally to the pool length the specific width of the channel has to be considered for the calculation [outside measurements according to the drawing on the right].
- Per corner an additional surcharge must be considered which depends on the specific shape of the corner.

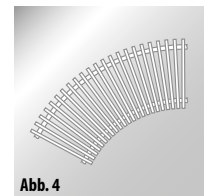
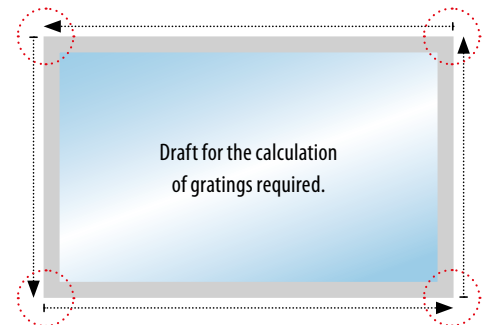

Drain valves



	Drain valve 2 1/2" for ø 85 mm	Drain valve 1 1/2" for ø 45 mm	Drain valve 2 1/2" for ø 85 mm	Drain valve 2 1/2" for ø 85 mm	Drain valve 1 1/2" for ø 50 mm
Outlet capacity	120 l/min	40 l/min	155 l/min	147 l/min	36 l/min
Description	with screw nut ABS plastic RAL 7040 [approx. 0,22 kg]	with screw nut ABS plastic RAL 7040 [approx. 0,07 kg]	with screw nut gunmetal, surface polished nickel/tin [ca. 1,47 kg]	with screw nut gunmetal, surface polished nickel/tin [ca. 1,60 kg]	with screw nut gunmetal, surface polished nickel/tin [ca. 0,32 kg]
Whith noise reduction	✓	✓	✓	-	-
	Article no. PG/pc 76 5202 910 901	Article no. PG/pc 76 5201 910 659	Article no. PG/pc 76 5202 920 915	Article no. PG/pc 76 5102 920 902	Article no. PG/pc 76 5101 920 900

FINA* STANDARD | WORLD CHAMPIONSHIPS

50 X 25 METER POOL FOR CHAMPIONSHIPS WITH LANE MARKING

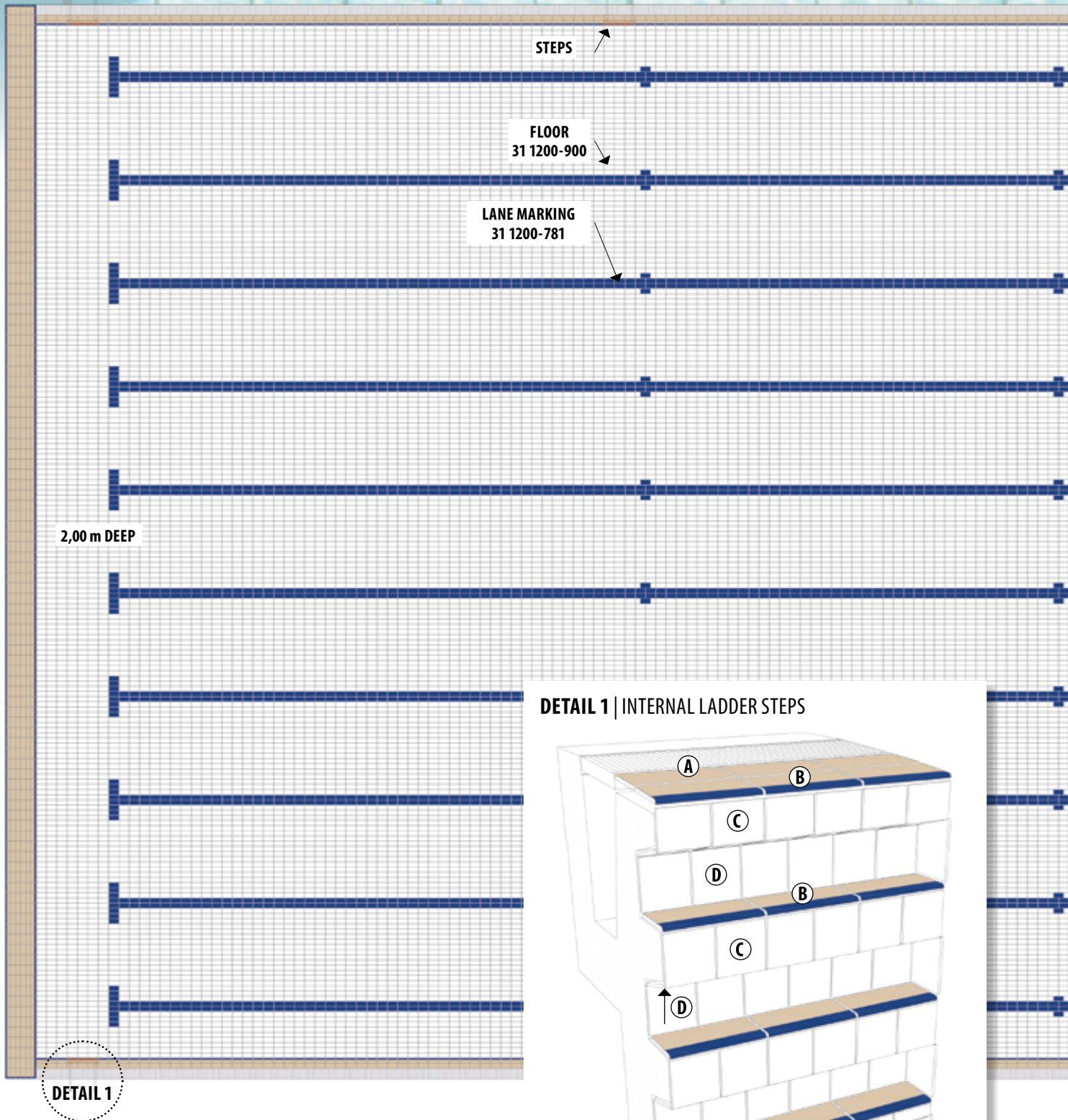

DETAIL 1 | INTERNAL LADDER STEPS

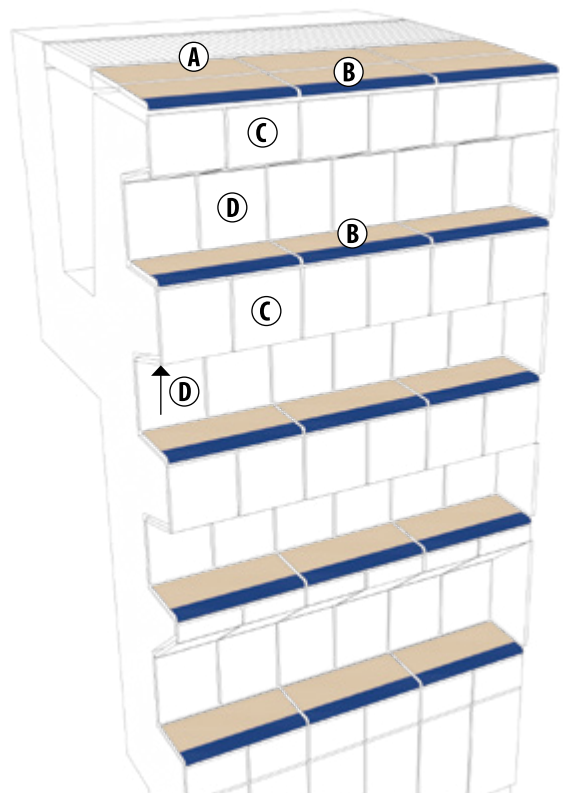

Item index | Detail 1 | Internal ladder steps

Item description	Article no.
A Small grooved tile grey-yellow antiskid "C"	66 3130 690
B Small grooved tile, long rounded edge w. safety marking	66 3136 690-788
C Basic tile standard white glossy, short rounded end	31 1200 900-KR
D Basic tile standard white glossy	31 1200 900

*FINA: The "Fédération Internationale de Natation" comprises 209 National Member Federations in the five continents. Today, FINA controls the development of aquatic events such as swimming, diving, water polo, synchronised swimming and open water swimming.

Professional realisation of swimming pools for olympic games and world championships according to FINA facility rules.
 Also applicable for diving facilities, pools for water polo and artistic swimming as well as 25 metre pools according to the guidelines.

DETAIL 2 | JUMP LEVEL/POOL EDGE

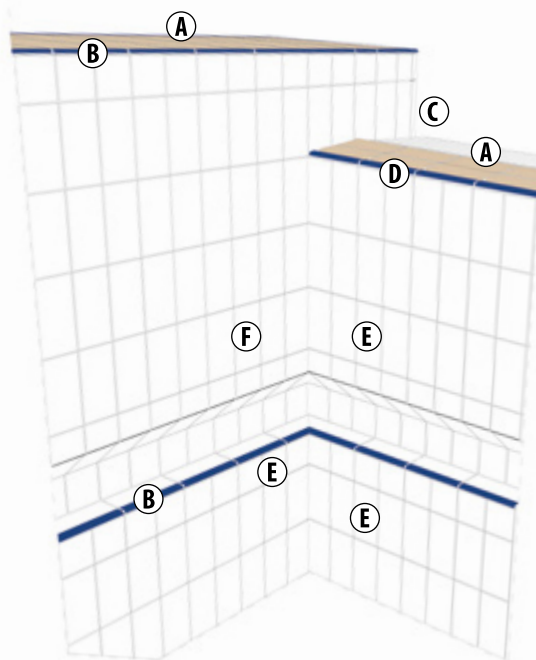

DETAIL 2

Item index | Detail 2 | Jump level/pool edge

Item description	Article no.
A Small grooved tile grey-yellow antiskid "C"	66 3130 690
B Small grooved tile, long edge rounded w. safety marking	66 3136 690-788
C Radial tiles, 30 mm white glossy	66 9450 900

Item description	Article no.
D Hand grip tile with safety marking grey-yellow antiskid "C"	66 5730 690-788
E Basic tile standard glazed, white glossy	31 1200 900
F Basic tile standard glazed, white antiskid "C"	31 1200 908

TECHNICAL INFORMATION



Cleaning and maintenance

Cleaning instructions for ceramic tiles

Compared to other covering materials, ceramic tiles grant excellent properties in maintenance. Long durability, easy cleaning combined with best hygiene characteristics and high functionality in private and public areas are the best reasons for this strong and decorative material. **interbau-blink** glazed and unglazed tiles are ideal for cleaning without problems. Please consider never to use cleaning agents containing hydrofluoric acid or its compounds (fluorides). They attack every ceramic even if diluted with plenty of water. Of course it makes sense to keep foot-scrapers, floor mats, cleaning zones and entrance areas clean too, in order to prevent the dirt getting inside in the first place.

For cleaning the following principles apply:

1. Choice of the appropriate cleaning agent.
2. Allow the cleaning agent sufficient time to act upon the dirt and to loosen it.
3. The process must be supported mechanically by brushing or wiping. Do not use pads or brushes with abrasive grain addition!
4. Collect the separated dirt thoroughly by washing and absorbing.

The first cleaning that takes place immediately after finishing the laying works should be done as follows:

First the coarse dirt is removed by sweeping. Afterwards, thorough cleaning follows by applying the appropriate cleaner. Cement residues can be removed with acid cleaning agents, so-called cement film removers. Please consider that acid cleaners attack cement joints. This can be prevented by protecting the joint through prewetting and thorough cleaning of the covering with clear water afterwards. Depending on the concentration, neutralization shall take place. Normal dirt can be removed best with alkaline or neutral cleaners.

Heavily frequented areas:

The cleaning is required according to the degree of dirt. In case of heavily frequented areas, cleaning should take place several times a day. In general, it is sufficient to use commercially available cleaners for the regular cleaning. Please consider that cleaners with combined long-term preparation possibly may cause layers of fat, wax or synthetic layers, which may have negative influence on the slip resistance and might harm the visual properties of the tile.

Difficult stains:

The easiest way to remove difficult stains, calcareous deposits, urine stone and metal abrasion residues is the application of acid cleaners. Consider to remove the acid cleaner completely by rinsing with clear water or neutralizing after sufficient time for the cleaner to act upon the dirt. Paint drops, tar or similar residues can easily be removed with gasoline, acetone or caustic pastes. This also applies for epoxy resin. Grease, wax and oil can be loosened by highly alkaline cleaners and are easy to remove afterwards.

Unglazed ceramics:

Unglazed ceramics without impregnation may show stains caused by this contamination, which can not be completely removed again. Unglazed ceramic tiles without in-plant upgrading should be impregnated as prevention in cases where practical experience shows that the floor may come into contact with grease or oil.

Special ceramics:

In our production programme you will find a wide range of slip resistant glazed and unglazed tiles. These products are specially developed for application in public, commercial, industrial areas as well as wet barefoot areas like swimming pools, showers, saunas etc. Depending on the area of application they have rough or profiled surfaces. The most effective method of cleaning is granted with brushing machines, high-pressure or vapour pressure cleaners. Do not use brushes or pads containing abrasives as they will have a negative impact on the slip resistance of the tile. Take care that the tile surface is thoroughly rinsed from cleaning liquids and disinfection liquids with clear water in order to prevent the floor covering to become slippery. For first and general cleaning we propose alkali based cleaning liquids. An acid cleaning should just be made from time to time depending on the degree of dirt and mainly depends on the type of water used. The German organization "Deutsche Gesellschaft für das Badewesen" has established a list with tested cleaning liquids for ceramic surfaces in swimming pools. These cleaners will also be proposed on our behalf for the cleaning of our tiles. Impregnation of glazed or unglazed ceramic surfaces may alter the performance characteristics (visual properties, slip resistance) of the ceramic.

Minimal iron lumps:

Due to the nature of ceramics minimal iron lumps may occur, which in single cases appear as small black spots. They do not influence the visual effect or quality.

Wet barefoot areas

Test procedure: Inclined plane, walked on barefoot, wetting agent solution as test medium. The surfaces are smooth, micro-rough, or slightly profiled. The respective areas are assigned to the valuation groups. Not all wet barefoot areas can be considered.



Valuation group A: Barefoot passages [nearly dry], individual and common dressing rooms, pool floors in the non-swimmer areas if the water depth is more than 80 cm in the entire area

Valuation group B: Barefoot passages [not classified in group A], showers, areas of disinfecting spray facilities, pool surrounds, pool floors in the non-swimmer areas [if the water depth is less than 80 cm in certain areas], pool floors in the non-swimmer areas of wave-action pools, moveable floors and paddling pools, ladders and stairs outside the pool area, sauna and relaxation areas [not classified in group A]

Valuation group C: Barefoot passages [not classified in group B], walk-through pools, inclined pool edge designs, ladders leading into the water, stairs leading into the water with a maximum width of 1 m and handrails on both sides

Advice: Tiles with the characteristic "B" resp. "C" and "B/C" for slip resistance should only be used in wet barefoot areas because of increased cleaning requirement.

Test on „inclined plane“

Valuation groups	An	
A	≥ 12°	
B	≥ 18°	
C	≥ 24°	

Valid standards and test results

General standards and tests EN 14411 group	Standard A _{1a} extruded stoneware	Test Value	Standard A _{1b} extruded stoneware	Test Value	Standard B _{1a} dry pressed fine stoneware	Test Value	Standard B _{1b} extruded stoneware	Test Value
E = water absorption	< 0,5 %		0,5 < E ≤ 3%		< 0,5 %		0,5 < E ≤ 3%	
Dimensions and surface properties								
Length and width: Permissible deviation from work size	± 1,0 %	fulfilled	± 1,0 %	fulfilled	± 0,75 %	fulfilled	± 0,75 %	fulfilled
Thickness: Permissible deviation from work size	± 10 %	fulfilled	± 10 %	fulfilled	± 5 %	fulfilled	± 5 %	fulfilled
Straightness of sides: Permissible deviation referring to the length of the sides	± 0,5 %	fulfilled	± 0,5 %	fulfilled	± 0,5 %	fulfilled	± 0,5 %	fulfilled
Rectangularity: Permissible deviation referring to the length of the sides	± 1,0 %	fulfilled	± 1,0 %	fulfilled	± 0,6 %	fulfilled	± 0,6 %	fulfilled
Surface flatness: Permissible deviation								
a) as centre camber of the diagonal, calculated from the work size	± 0,5 %	fulfilled	± 0,5 %	fulfilled	± 0,5 %	fulfilled	± 0,5 %	fulfilled
b) as side camber referring to the corresponding work size	± 0,5 %	fulfilled	± 0,5 %	fulfilled	± 0,5 %	fulfilled	± 0,5 %	fulfilled
c) as inclined plane referring to the diagonal, calculated from the work size	± 0,8 %	fulfilled	± 0,8 %	fulfilled	± 0,5 %	fulfilled	± 0,5 %	fulfilled
Surface quality: Accepted tiles	at least 95 %	fulfilled	at least 95 %	fulfilled	at least 95 %	fulfilled	at least 95 %	fulfilled
Physical Properties								
Water absorption (average value in %)	< 0,5 %	< 0,5 %	0,5 < E ≤ 3,0 %	< 1,5 %	< 0,5 %	< 0,5 %	0,5 < E ≤ 3,0 %	< 2,5 %
Breaking load in N/mm ² depending on the thickness of the material	7,5 mm > 1.100 N		8 mm > 1.280 N 9 mm > 1.620 N 10 mm > 2.000 N		10 mm > 2.000 N		6 mm > 720 N 7 mm > 1.030 N 8 mm > 1.280 N 9 mm > 1.620 N 10 mm > 2.000 N	
Frost resistance	required	fulfilled	required	fulfilled	required	fulfilled	required	fulfilled
Resistance to surface abrasion of glazed tiles	class I - IV	acc. to specifications	class I - IV	acc. to specifications	class I - IV	acc. to specifications	class I - IV	acc. to specifications
Resistance to abrasion of unglazed tiles/loss in volume in mm ³	max. 275	< 210	max. 275	< 210	max. 175		max. 275	< 210
Thermal shock resistance	required	fulfilled	required	fulfilled	required	fulfilled	required	fulfilled
Thermal coefficient of expansion at ambient temperature of up to 100°C in K ⁻¹		6 - 7,5 x 10 ⁻⁶		5 - 13 x 10 ⁻⁶		8 x 10 ⁻⁶		
Chemical Properties								
Resistance to chemicals – except to hydrofluoric acid and its compounds for unglazed tiles	required	fulfilled	required	fulfilled	required	fulfilled	required	fulfilled
for glazed tiles								
a) to acids and alkali	acc. to specifications	fulfilled	acc. to specifications	fulfilled	acc. to specifications	fulfilled	acc. to specifications	fulfilled
b) to stains	min. class III	fulfilled	min. class III	fulfilled	min. class III	fulfilled	min. class III	fulfilled
c) to household chemicals	min. class GB	fulfilled	min. class GB	fulfilled	min. class GB	fulfilled	min. class GB	fulfilled
d) to swimming pool additives	min. class GB	fulfilled	min. class GB	fulfilled	min. class GB	fulfilled	min. class GB	fulfilled
Resistance to glaze cracking	required	fulfilled	required	fulfilled	required	fulfilled	required	fulfilled
Slip resistance								
Industrial areas	R 9 - R 12	acc. to specifications	R 9 - R 12	acc. to specifications	R 9 - R 13	acc. to specifications	R 9 - R 12	acc. to specifications
Wet barefoot areas	A - C	acc. to specifications	A - C	acc. to specifications	A - C	acc. to specifications	A - C	acc. to specifications
Private areas	Recommend.: R 9	acc. to specifications	Recommend.: R 9	acc. to specifications	Recommend.: R 9	acc. to specifications	Recommend.: R 9	acc. to specifications

The indicated property values are average values. All specifications correspond to the current state of our knowledge, however do not represent the promise of the properties. Subject to technical modifications.

Table of the respective stress groups according to the PEI wet method DIN EN ISO 10545-7

Stress group	Rotation	Valuation
I	150	very light traffic load e.g. bathrooms walked on in soft footwear
II	300 - 600	light traffic load e.g. living areas & bathrooms walked on in normal footwear, exposed to some abrasive dirt
III	750 - 1500	medium traffic load e.g. living areas, loggias, corridors, terraces, balconies
IV	> 1500	higher traffic load e.g. entrance areas, offices, sales rooms, industrial and commercial areas
V	> 12000	very high traffic load e.g. restaurants, shops, counter areas

ITEM INDEX

Item no.	Article no.	Item description	Page
1200	31 1200	Basic tile standard	10-15
1212	32 1212	Basic tile small*	10-15
2424	32 2424	Basic tile large*	10-15
1100	41 1100	Split tile* stoneware	11-15
2120	43 2120	Split tile* stoneware	11-13
1150	66 1150	Large tile	39
1155	66 1155	Large tile, short edge rounded [KR]	39
1156	66 1156	Large tile, long edge rounded [LR]	39
1157	66 1157	Large tile, corner rounded left [ER left]	39
1158	66 1158	Large tile, corner rounded right [ER right]	39
3130	66 3130	Small grooved tile	37
3136	66 3136	Small grooved tile, long edge rounded with safety marking	37
3170	66 3170	Diamond shaped tile	39
3190	66 3190	Large grooved tile	37
3195	66 3195	Safety strip tile	37
3196	66 3196	Large grooved tile long edge rounded with safety marking	37
4000	66 4000	Coved skirting tile	35
4002	66 4002	Internal corner, set of two pcs to coved skirting tile 4000	35
4007	66 4007	External corner, set of two pcs to coved skirting tile 4000	35
4100	66 4100	Coved tile	35
4101	66 4101	Coved stop end to coved tile 4100	35
4102	66 4102	Internal corner to coved tile 4100	35
4104	66 4104	Coved corner tile left to coved tile 4100	35
4106	66 4106	Coved corner tile right to coved tile 4100	35
4107	66 4107	External corner for coved skirting to coved tile 4100	35
4500	66 4500	Gutter tile for open channel systems	41
4501	66 4501	Drainage for 1 ½" ø = 50 mm to gutter tile 4500	41
4502	66 4502	Mitred pair, set of two pcs to gutter tile 4500	41
4504	66 4504	Stop end to gutter tile 4500	41
4505	66 4505	½ Gutter tile for open channel systems to gutter tile 4500	41
4710	66 4710	Step tile, long edge rounded with safety marking	37
4822	66 4822	External angle tile	41
4900	66 4900	Channel for channel cladding	41
4905	66 4905	½ Channel for channel cladding	41
4901	66 4901	Channel with drainage ø = 85 mm for channel cladding	41
5100	66 5100	Overflow channel, large System Wiesbaden low water level	23
5101	66 5101	Overflow channel with drainage ø = 85 mm to overflow channel 5100	23
5102	66 5102	Internal corner, set of two pcs to overflow channel 5100	23
5104	66 5104	Stop end left to overflow channel 5100	23
5105	66 5105	½ Overflow channel, large to overflow channel 5100	23
5106	66 5106	Stop end right to overflow channel 5100	23
5107	66 5107	External corner, set of two pcs to overflow channel 5100	23
5110	66 5110	Overflow channel System Therapy	23
5111	66 5111	Overflow channel with drainage ø = 50 mm to overflow channel 5110	23
5112	66 5112	Internal corner, set of two pcs to overflow channel 5110	23
5114	66 5114	Stop end left to overflow channel 5110	23
5115	66 5115	½ Overflow channel to overflow channel 5110	23
5116	66 5116	Stop end right to overflow channel 5110	23
5117	66 5117	External corner, set of two pcs to overflow channel 5110	23
5150	66 5150	Overflow channel System Berlin	29
5152	66 5152	Internal corner, set of two pcs to overflow channel 5150	29
5155	66 5155	½ Overflow channel to overflow channel 5150	29
5157	66 5157	External corner, set of two pcs to overflow channel 5150	29
5170	66 5170	Overflow channel small System Wiesbaden high water level	19
5171	66 5171	Overflow channel with drainage ø = 85 mm to overflow channel 5170	19
5172	66 5172	Internal corner, set of two pcs to overflow channel 5170	19
5174	66 5174	Stop end left to overflow channel 5170	19
5175	66 5175	½ Overflow channel to overflow channel 5170	19
5176	66 5176	Stop end right to overflow channel 5170	19
5177	66 5177	External corner, set of two pcs to overflow channel 5170	19
5270	66 5270	Overflow channel small System Wiesbaden with recess	21
5271	66 5271	Overflow channel with drainage ø = 85 mm w. recess to item 5270	21
5272	66 5272	Internal corner, set of two pcs with recess to overflow channel 5270	21
5274	66 5274	Stop end left with recess to overflow channel 5270	21
5275	66 5275	½ Overflow channel with recess to overflow channel 5270	21
5276	66 5276	Stop end right with recess to overflow channel 5270	21
5277	66 5277	External corner, set of two pcs with recess to overflow channel 5270	21
5300	66 5300	Overflow channel large System Wiesbaden high water level	19
5301	66 5301	Overflow channel with drainage ø = 85 mm to overflow channel 5300	19
5302	66 5302	Internal corner, set of two pcs to overflow channel 5300	19
5304	66 5304	Stop end left to overflow channel 5300	19
5305	66 5305	½ Overflow channel to overflow channel 5300	19

5306	66 5306	Stop end right to overflow channel 5300	19
5307	66 5307	External corner, set of four pcs to overflow channel 5300	19
5400	66 5400	Pool edging tile with vertical front System Skimmer	31
5402	66 5402	Internal corner, set of two pcs to pool edging tile 5400	31
5407	66 5407	External corner with vertical front, set of two pcs to pool edging tile 5400	31
5450	66 5450	Pool edging tile with vertical front/hand grip	31
5452	66 5452	Internal corner with hand grip, set of two pcs to pool edging tile 5450	31
5457	66 5457	External corner with vertical front/hand grip, set of two pcs to item 5450	31
5460	66 5460	Pool edging tile with vertical front individual foothold area	31
5462	66 5462	Internal corner, set of two pcs, individual foothold area to item 5460	31
5467	66 5467	External corner, set of two pcs, individual foothold area to item 5460	31
5480	66 5480	Edging tile with safety marking	31
5487	66 5487	External corner, set of two pcs to edging tile 5480	31
5482	66 5482	Internal corner, set of two pcs to edging tile 5480	31
5500	66 5500	Overflow channel, large System Wiesbaden with recess	21
5501	66 5501	Overflow channel with drainage ø = 85 mm to overflow channel 5500	21
5502	66 5502	Internal corner, set of two pcs with recess to overflow channel 5500	21
5504	66 5504	Stop end left with recess to overflow channel 5500	21
5505	66 5505	½ Overflow channel, large with recess to overflow channel 5500	21
5506	66 5506	Stop end right with recess to overflow channel 5500	21
5507	66 5507	External corner, set of four pcs with recess to overflow channel 5500	21
5560	66 5560	Ladder step tile, short	39
5565	66 5565	Ladder step tile, long	39
5700	66 5700	Angle step tile with grooved surface	37
5730	66 5730	Hand grip tile, with safety marking	27
5732	66 5732	Internal corner, set of two pcs to hand grip tile 5730	27
5737	66 5737	External corner, set of two pcs to hand grip tile 5730	27
5750	66 5750	Pool edging tile, with safety marking	31
5752	66 5752	Internal corner, set of two pcs to pool edging tile 5750	31
5757	66 5757	External corner, set of two pcs to pool edging tile 5750	31
5810	66 5810	Hand grip tile with grating support, with safety marking	27
5812	66 5812	Internal corner, set of two pcs to hand grip tile 5810	27
5817	66 5817	External corner, set of two pcs to hand grip tile 5810	27
5820	66 5820	Grooved tile with grating support 107°	27
5822	66 5822	Internal corner, set of two pcs to grooved tile 5820	27
5827	66 5827	External corner, set of two pcs to grooved tile 5820	27
5830	66 5830	Edging tile with grating support	27
5832	66 5832	Internal corner, set of two pcs to edging tile 5830	27
5837	66 5837	External corner, set of two pcs to edging tile 5830	27
5930	66 5930	Edging tile with grating support 83°	27
6450	66 6450	Radial tile, radius 60 mm	33
6453	66 6453	External corner 3 to radial tile 6450, for three sides connected	33
6454	66 6454	External corner 2 to radial tile 6450, for two sides connected	33
6457	66 6457	External corner K8 with connection to radial tile 60 mm	33
6462	66 6462	Internal corner R86 to item 6450, with connection to coved tile	33
9039	66 9039	Angle tile, with grating support 90°	41
9050	66 9050	Angle tile, with grating support 107°	41
9450	66 9450	Radial tile, radius 30 mm	33
9452	66 9452	Internal corner to item 9450, with connection to coved tile	33
9453	66 9453	External corner 3 to radial tile 9450, for three sides connected	33
9454	66 9454	External corner 2 to radial tile 9450, for two sides connected	33
-	76 1215	Grating, rigid width 150 mm	43
-	76 1218	Grating, rigid width 185 mm	43
-	76 1220	Grating, rigid width 200 mm	43
-	76 1225	Grating, rigid width 250 mm	43
-	76 1230	Grating, rigid width 300 mm	43
-	76 1235	Grating, rigid width 350 mm	43
-	76 1240	Grating, rigid width 400 mm	43
-	76 2215	Parallel grating, rigid width 150 mm	43
-	76 2218	Parallel grating, rigid width 185 mm	43
-	76 2220	Parallel grating, rigid width 200 mm	43
-	76 2225	Parallel grating, rigid width 250 mm	43
-	76 2230	Parallel grating, rigid width 300 mm	43
-	76 3215	Cross grating, roll-up design width 150 mm	43
-	76 3218	Cross grating, roll-up design width 185 mm	43
-	76 3220	Cross grating, roll-up design width 200 mm	43
-	76 3225	Cross grating, roll-up design width 250 mm	43
-	76 3230	Cross grating, roll-up design width 300 mm	43
-	76 5101 920	Drain valve 1 ½" gunmetal, ø = 50 mm	43
-	76 5102 920	Drain valve 2 ½" gunmetal, ø = 85 mm	43
-	76 5201 910	Drain valve 1 ½", silent ABS plastic, ø = 45 mm	43
-	76 5202 910	Drain valve 2 ½", silent ABS plastic, ø = 85 mm	43
-	76 5202 920	Drain valve 2 ½", silent gunmetal, ø = 85 mm	43

* Order related production, please request minimum order quantities (MOQ).

VarioCOLOR PROGRAMME

COLOURS AND SURFACES

Colour groups | glazed | semi gloss

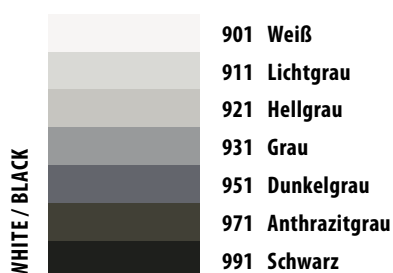
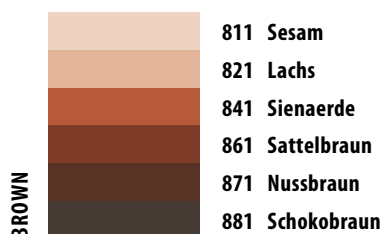
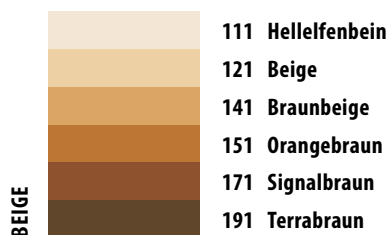
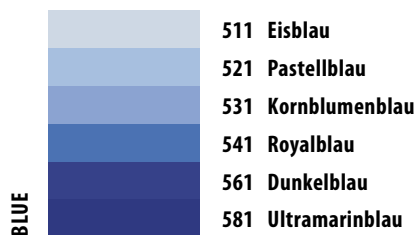
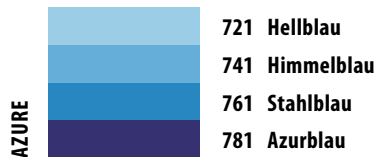
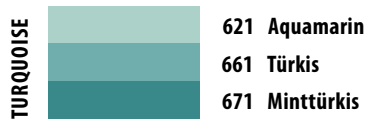
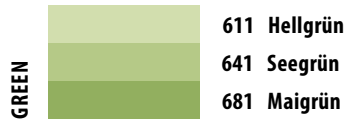
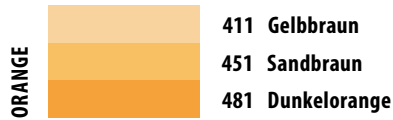
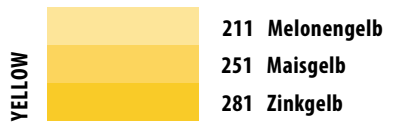

Intensive and basic colours | glazed | glossy

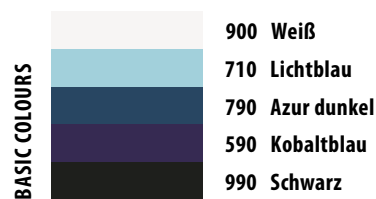
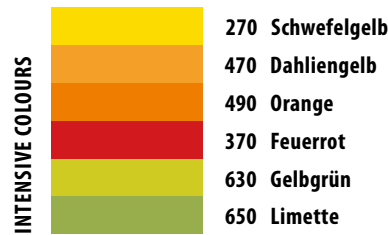

Slip resistant | glazed

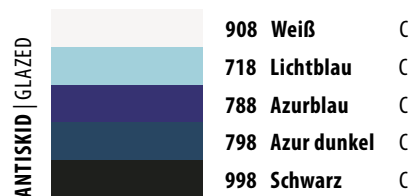
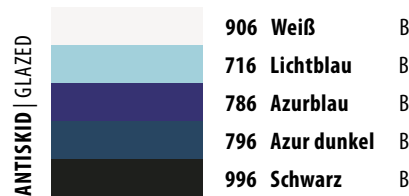

Slip resistant | unglazed

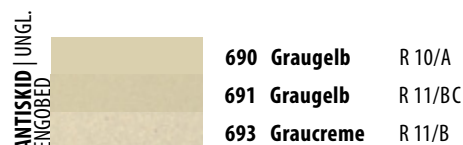
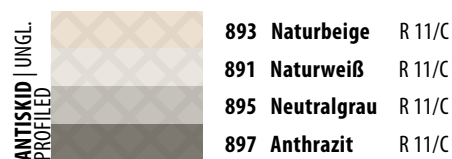
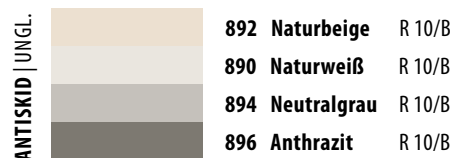

Evers Fliser

4343 4315

www.evers.dk | salg@evers.dk